

LIVING STREAMBANKS

A Manual of Bioengineering Treatments for Colorado Streams

Submitted To: State of Colorado, Colorado Water Conservation Board
1313 Sherman St, Room 718
Denver, CO 80201

Submitted By: AloTerra Restoration Services, LLC, and
Golder Associates, Inc.

Primary Authors:

John H. Giordanengo¹
Randy H. Mandel²
William J. Spitz³
Matthew C. Bossler¹
Michael J. Blazewicz⁴
Steven E. Yochum⁵
Katie R. Jagt⁶
William J. LaBarre²
Grant E. Gurnee⁷
Robert Humphries²
Kelly T. Uhing⁸

1. AloTerra Restoration Services, LLC; 2. Golder Associates, Inc.; 3. Olsson Associates;
4. Round River Design, LLC; 5. USFS, National Stream and Aquatic Ecology Center;
6. Watershed Science and Design, PLLC; 7. Ecosystem Services, LLC; 8. Denver Parks -
Natural Resources Division.

Date: July 24, 2016



COLORADO

Colorado Water
Conservation Board

Department of Natural Resources



AloTerra
Restoration Services, LLC

Acknowledgements

This project was made possible by the generous support of the Colorado Water Conservation Board, whose leadership following the 2013 Colorado Front Range floods was instrumental in helping local communities recover from this natural disaster. We wish to thank Rocky Mountain Flycasters (a chapter of Colorado Trout Unlimited) and the contributions of the Technical Review Committee, whose input and editing resulted in a reference manual with value beyond any single agency, organization, or individual.

Online Access to 2016 Edition of Bioengineering Manual and Revegetation Matrix

This bioengineering manual and companion revegetation matrix are available from the following websites:

Colorado Water Conservation Board:

<http://cwc.state.co.us/environment/watershed-protection-restoration/Pages/main.aspx>

Emergency Watershed Protection website (Technical Assistance Team page):

<http://coloradoewp.com/guidelines-and-resources>

The 2016 edition of this manual, and future editions, may be requested by contacting AloTerra Restoration Services: 970-420-7346 or john@aloterraservices.com.

TECHNICAL REVIEW COMMITTEE

We are truly thankful to the following individuals who comprised our Technical Review Committee and provide input into the content and direction of this manual.

| NAME | AFFILIATION |
|------------------|---|
| John Andrews | Natural Resources Conservation Services |
| Julie Ash | Otak |
| Lucas Babbitt | Michael Baker International |
| Laura Backus | Institute for Arctic and Alpine Research |
| Mike Bannister | RESPEC |
| Mike Banovich | Colorado Department of Transportation |
| Tom Bates | USFS, Arapaho & Roosevelt National Forests |
| Millissa Berry | James Creek Watershed Initiative |
| Tee Burr | Natural Resources Conservation Services |
| Ken Cecil | J3 Engineering |
| Bill Coughlin | Western Stream Works |
| Jeff Crane | Crane Associates |
| Jon Danzvardis | Ecosystem Services |
| Claire Deleo | Boulder County Parks and Open Space |
| William Derosset | Ayres Associates |
| Corey Engen | FlyWater |
| Richard England | Independent |
| Greg Fischer | Colorado Department of Transportation |
| Kyle Hamilton | CH2M Hill |
| David Hirt | Boulder County Parks and Open Space |
| Robert Humphries | Golder Associates |
| Tracy Kittell | Colorado Parks and Wildlife |
| Mac Kobza | Boulder County Parks and Open Space |
| Jenelle Kreutzer | ERO Resouces |
| Jim Krick | City of Longmont Parks, Open Space & Forestry |
| Denise Larson | ERO Resouces |
| Kim Lenneberg | Independent |
| Morgan Lynch | CH2M hill |
| Randy Mandel | Golder Associates |
| Jessie Olson | Lefthand Watershed Oversight Group |
| Becky Pierce | Colorado Department of Transportation |
| David Piske | Rocky Mountain Flycasters |
| Basil Ryer | Colorado Department of Transportation |
| Bill Schenderlin | Blue Earth Solutions |
| Vince Sortman | Biohabitats |
| Chris Sturm | Colorado Water Conservation Board |
| Mike Thomas | Boulder County Transportation |
| Randy Walsh | Stantec Consulting |

EXECUTIVE SUMMARY

The 2013 Front Range Floods were highly detrimental to Colorado, impacting human life, infrastructure, and water quality. Furthermore, the flood caused historic levels of damage to stream channels, floodplains, and riparian areas. To assist the multiple communities and watersheds impacted by the 2013 disaster, the Colorado Department of Natural Resources, Colorado Water Conservation Board provided funding through Rocky Mountain Flycasters (a chapter of Colorado Trout Unlimited) for the creation of this bioengineering manual. Bioengineering practices provide resiliency for streambanks, enhance wildlife habitat, enhance organic matter inputs to streams, improve water quality, increase floodplain roughness, and heighten landscape aesthetics so important to countless residents, visitors, and businesses. Accordingly, the authors have created the following manuscript to:

- ◆ Provide guidelines for a comprehensive bioengineering strategy;
- ◆ Incorporate design elements that impart site stability and resilience;
- ◆ Include project recommendations that minimize risk during periods of vulnerability;
- ◆ Increase understanding of how to properly apply bioengineering and revegetation techniques;
- ◆ Provide background resources on the combined forces of water and gravity as they pertain to bioengineered structures; and
- ◆ Create a searchable *Revegetation Matrix* for the primary native restoration species useful for flood recovery and other riparian areas throughout Colorado.

As the development of this manual is an iterative process, the authors thank you for taking the time to review our recommendations and welcome your feedback on how collectively we can better increase our knowledge and understanding of these practices as a restoration and engineering community.

TABLE OF CONTENTS

| | |
|--|-----------|
| EXECUTIVE SUMMARY | III |
| TABLE OF CONTENTS..... | IV |
| 1.0 INTRODUCTION | 1 |
| 1.1 RIVER COMPLEXITY AND STREAMBANK BIOENGINEERING..... | 1 |
| <i>Basic terminology used in this manual</i> | 3 |
| <i>Form- v. Process-Based Approaches to Bioengineering</i> | 3 |
| <i>Plant-based v. Structural-based Approaches to Bioengineering: a convenient division</i> | 4 |
| 1.2 GOALS AND OBJECTIVES..... | 4 |
| <i>Manual Organization</i> | 7 |
| <i>Disclaimer</i> | 8 |
| 2.0 DESIGN WITH RISK IN MIND | 9 |
| 2.1 UNCERTAINTY IN RIVER RESTORATION AND STREAMBANK STABILIZATION PROJECTS | 9 |
| <i>Uncertainty vs Risk</i> | 9 |
| 2.2 FAILURE RISK MITIGATION | 10 |
| <i>Post-Construction</i> | 11 |
| <i>Lowest water table of the year</i> | 12 |
| <i>High Magnitude Discharge Events</i> | 13 |
| 2.3 CONCLUDING REMARKS | 14 |
| 3.0 STREAM MECHANICS..... | 15 |
| 3.1 FUNDAMENTAL MECHANISMS..... | 15 |
| <i>Sediment Transport</i> | 15 |
| <i>Shear Stress</i> | 15 |
| <i>Sediment Load</i> | 16 |
| <i>Stream Power</i> | 16 |
| <i>Total Stream Power</i> | 17 |
| <i>Unit Stream Power</i> | 17 |
| 3.2 LANE’S BALANCE | 18 |
| 3.3 CHANNEL AND FLOODPLAIN PROCESSES | 20 |
| <i>Channel Type</i> | 20 |
| <i>Channel Evolution</i> | 23 |
| <i>Stream Capacity</i> | 29 |
| <i>Lay-down of Vegetation</i> | 29 |
| 3.4 STREAMBANK CHARACTERISTICS | 31 |
| <i>Bank Material</i> | 31 |
| <i>Bank Retreat</i> | 31 |
| <i>Bank Angle</i> | 32 |
| <i>Soil Properties and Geotechnical Stability</i> | 32 |
| 3.5 DESIGN CRITERIA..... | 33 |
| <i>Bankfull and Effective Discharge</i> | 33 |
| <i>Bankfull Channel Elevation</i> | 34 |
| <i>Flood Discharge</i> | 35 |
| <i>Flood Event Recurrence Interval</i> | 35 |
| 3.6 EVALUATING BIOENGINEERING TOLERANCES..... | 36 |
| <i>Maximum permissible velocity</i> | 37 |
| <i>Critical Velocity</i> | 37 |
| <i>Shear Stress & Critical Shear Stress</i> | 37 |

| | | |
|------------|--|-------------------------------------|
| | <i>Impact of Vegetation on Lift and Drag Forces</i> | 40 |
| | <i>Correlation of Bioengineering Treatments to Permissible Shear Stress and Velocity</i> | 42 |
| 3.7 | CONCLUDING REMARKS | 47 |
| 4.0 | PLANT-BASED BIOENGINEERING: DESIGN CONSIDERATIONS | 48 |
| | <i>Plant-Based Bioengineering Approach</i> | 48 |
| 4.1 | CHARACTERIZATION OF RIPARIAN SYSTEMS..... | 48 |
| | <i>Streambank Zoning</i> | 49 |
| | <i>Plant Community Succession</i> | 51 |
| | <i>Riparian Vegetation Functional Groups</i> | 54 |
| 4.2 | PLANT-BASED DESIGN CONSIDERATIONS..... | 55 |
| | <i>Influence of Bank Angle on Vegetation Establishment</i> | 55 |
| | <i>Water Supply</i> | 56 |
| | <i>Root Parameters and Bank Strength</i> | 57 |
| | <i>Timing of Plant Establishment</i> | 63 |
| | <i>Plant Community Trajectory Planning</i> | 64 |
| | <i>Management of Soil Surface Erosion</i> | 65 |
| | <i>Irrigation</i> | 66 |
| 4.3 | REVEGETATION MATRIX..... | 66 |
| 4.4 | CONCLUDING REMARKS | 67 |
| 5.0 | PLANT-BASED BIOENGINEERING: TREATMENTS | 69 |
| 5.1 | LIVE CUTTINGS AND POLES | 70 |
| | <i>Ethical Harvesting Guidelines</i> | 73 |
| | <i>Cuttings and Live Stakes</i> | 73 |
| | <i>Other Plant Materials</i> | 75 |
| 5.2 | STRUCTURES INVOLVING MULTIPLE CUTTINGS..... | 80 |
| | <i>Fascine Bundles</i> | 80 |
| | <i>Brush Layering and Brush Packing</i> | 82 |
| | <i>Brush Mattressing</i> | 83 |
| 5.3 | OTHER PLANT-BASED EROSION CONTROL TREATMENTS | 84 |
| | <i>Coconut Fiber Rolls</i> | 84 |
| | <i>Seeding</i> | 85 |
| | <i>Soil Amendments</i> | 86 |
| | <i>Humate</i> | 86 |
| | <i>Compost</i> | 87 |
| | <i>Soil Fungi Inoculation</i> | 87 |
| | <i>Soil surface protection</i> | 88 |
| | <i>Erosion Control Blankets and Geotextiles</i> | 88 |
| | <i>Hydromulching</i> | 89 |
| | <i>Dry Mulches</i> | 90 |
| | <i>Weed-free Mulch is Imperative</i> | 91 |
| | <i>Straw Wattles</i> | 91 |
| 5.4 | CONCLUDING REMARKS | 91 |
| 6.0 | STRUCTURAL-BASED BIOENGINEERING: DESIGN CONSIDERATIONS | 93 |
| 6.1 | TOE PROTECTION | 93 |
| 6.2 | LARGE WOODY MATERIAL / DEBRIS..... | 94 |
| 6.3 | FACTOR OF SAFETY | 95 |
| | <i>Factor of Safety Formulae</i> | Error! Bookmark not defined. |
| | <i>Factor of Safety Variables (Formulae)</i> | Error! Bookmark not defined. |
| 6.4 | NON-WOODY TOE STRUCTURES | 95 |
| | <i>Plant Rolls</i> | 95 |
| | <i>Wraps</i> | 96 |
| 6.5 | CONCLUDING REMARKS | 96 |

| | | |
|------------|--|------------|
| 7.0 | STRUCTURAL-BASED BIOENGINEERING: TREATMENTS | 97 |
| 7.1 | BASIC TREE STRUCTURES..... | 97 |
| | <i>Single Log</i> | 97 |
| | <i>Root Wads</i> | 97 |
| | <i>Tree Revetment</i> | 98 |
| 7.2 | INCORPORATION OF ANCHORS | 100 |
| 7.3 | REDIRECTIVE STRUCTURES..... | 101 |
| | <i>Large Woody Debris Structures</i> | 101 |
| | <i>Rock, Log, and J-Hook Vanes</i> | 102 |
| 8.0 | INTEGRATION OF PLANT-BASED AND STRUCTURAL-BASED BIOENGINEERING | 106 |
| 8.1 | INTRODUCTION | 106 |
| 8.2 | VEGETATED RIPRAP..... | 106 |
| 8.3 | VEGETATED CRIB STRUCTURES | 110 |
| 8.4 | VEGETATED SOIL LIFTS..... | 112 |
| 8.5 | CONCLUDING REMARKS | 114 |
| 9.0 | MANAGEMENT, MAINTENANCE, AND MONITORING | 115 |
| 9.1 | MANAGEMENT | 115 |
| | <i>Invasion of Non-native Plants</i> | 116 |
| | <i>Livestock and Wildlife Control</i> | 118 |
| 9.2 | MAINTENANCE..... | 119 |
| 9.3 | MONITORING | 120 |
| 9.4 | REFERENCE CONDITIONS AND REFERENCE REACH..... | 120 |
| 9.5 | MONITORING CRITERIA AND METHODS | 121 |
| 9.6 | CONCLUDING REMARKS | 124 |
| | REFERENCES..... | 125 |
| | APPENDICES..... | A |
| | A. FIELD GUIDE FOR HARVESTING AND INSTALLING WILLOW AND COTTONWOOD CUTTINGS..... | A |

1.0 INTRODUCTION

The purpose of this manual is to provide restoration practitioners and regulators who work in Colorado with guidelines for planning, design, and construction of streambank protection. In particular, it prioritizes the application of streambank bioengineering treatments tailored for the climatic, biological, hydrologic, and morphological conditions specific to Colorado's unique watersheds. The streambank bioengineering treatments presented in this manual were developed by their original authors to withstand specific hydraulic conditions of a site while utilizing site-adapted vegetation. The treatments presented provide restoration practitioners with alternatives to traditional, structural-focused treatments, and place an emphasis on treatments that incorporate plant-based treatments with structural-based treatments to form a variety of integrated treatments. While there is a gamut of bioengineering treatments available for floodplain restoration and slope stabilization, this manual focuses on those treatments intended to decrease the rate of streambank erosion and enhance the living component of streambanks.

Multiple published methods are available for bioengineering and traditional bank stabilization treatments to address design needs throughout North America. While this manual strongly considers those contributions, and directs the reader to those resources where appropriate, Colorado's unique hydraulic and ecological conditions require a localized approach to streambank bioengineering to enhance successful implementation of treatments. Success of streambank bioengineering treatments is further guided throughout this manual via design and construction strategies specific to Colorado.

1.1 RIVER COMPLEXITY AND STREAMBANK BIOENGINEERING

Rivers are inherently dynamic, interconnected systems. Some characteristics of river systems exhibit nearly static patterns over short periods, yet are highly variable over long time scales. As such, the dynamic nature of rivers is temporal. On both short and long time scales, *abiotic* (i.e., geology, hydrology, precipitation patterns, and other non-living elements) and *biotic* (plants, soil microbes, grazers, aquatic organisms, etc.) components of river systems influence one another in a dynamic manner. As such, rivers are open systems in that these components produce feedback loops important to enhancing the resiliency of the system over time. Simply put, rivers are complex.

This dynamic, interconnected riverine system is not readily apparent to the casual observer. Those who have attempted to force a river to assume a particular pattern and profile over a particular timeline have often failed. Traditional structural-based engineering has for many years succeeded in constraining fluvial systems in order to provide protection of public safety, property, and critical

infrastructure, though never to a level that eliminates risk of failure to achieve design goals. However, traditional approaches may accept or ignore associated disruptions to biological systems, water quality, or the natural character of rivers that encourages the development of communities to their sides. In addition, the cost of traditional structural-based river engineering is substantial, in terms of design cost and with respect to the labor, machinery, and materials required for their construction and maintenance.

Colorado's history of flooding reminds us that, while we can design river systems to perform under specific conditions, these designs are either expected to fail under predicted scenarios, or they are at risk of failure due to unpredicted circumstances. One wide-spread example of failure noted after the 2013 Front Range floods is riprap revetment. In many reaches, well-designed riprap revetments withstood the forces of this major event, while in other reaches similar riprap revetment failed to the detriment of the infrastructure it aimed to protect. By virtue of their construction, however, riprap revetments typically remove riparian plant communities and the beneficial functions they provide, resulting in a coarse, unapproachable riverside where there once was a natural bank.

Important philosophical questions asked by this manual are: "If traditional engineering treatments such as riprap knowingly disrupt or destroy the biotic components of a river system, resulting in barren, aesthetically displeasing banks, is it not the responsibility of the planner and designer to consider bioengineering alternatives that can perform as well or better? Additionally, if such bioengineering treatments accomplish multiple objectives (i.e., habitat improvement, sediment reduction, stream shading, etc.) deemed valuable by vested constituents, aren't our projects and clients better served by such treatments?" In response, engineers and floodplain managers have successfully applied streambank bioengineering treatments throughout Colorado. In doing so, they balance infrastructural needs with the myriad positive values a healthy river corridor provides.

Ecological and Social Benefits of Bioengineering

In addition to the bank protection afforded by streambank bioengineering treatments, such treatments can be designed to improve stream and terrestrial wildlife habitat, enhance stream corridor aesthetics, improve water quality, enhance the experience of recreationists, tourists, and vacation communities, and support other social and ecological values otherwise unattainable by an engineered approach alone. Riparian areas comprise less than one percent of the land area of most western states (Cooperrider, Boyd, and Stuart, 1986), yet up to 80 percent of all wildlife species in the west are dependent upon riparian areas for at least part of their life cycles (Wayland, 1997). Healthy riparian areas provide irreplaceable wildlife habitat for breeding, wintering, and migration of wildlife, including rare species such as Preble's meadow jumping mouse (*Zapus hudsonius spp. preblei*), bald eagles (*Haliaeetus leucocephalus*), and others. Given the low occurrence of riparian ecosystems on the landscape, the high value they provide for wildlife, and given the fact riparian systems in the Western U.S. are the most productive habitats in North America (Johnson, Haight, and Simpson, 1977), the rationale for their protection and restoration becomes clear.

In order to facilitate the incorporation of ecological and social values into the planning and design of stream and floodplain projects, this manual highlights specific design considerations and details to help improve the success of such treatments, thus reducing risk that exists during vulnerable post-construction periods.

Basic terminology used in this manual

Throughout this manual, key terms that are essential to the comprehension of presented content are *italicized* when first used, and subsequently defined. In this manual, we use the term *bioengineering* instead of “biostabilization”. While both terms are similarly descriptive, the former has been chosen due to its integration of both biological and engineering roots. Furthermore, referring to “soil” bioengineering deemphasizes the role vegetation plays in bioengineering treatments, such as stream shading, organic inputs, reductions in shear stress, and other “non-soil” components of the floodplain. For this reason, this manual avoids the use of the term “soil bioengineering”. In short, the benefits of bioengineering go far beyond protecting soil.

The term *treatment* is used with respect to the design, construction, and as-built result of an individual bioengineering unit. Similar terms that have been used in the literature to describe *treatments* include “treatments,” “components,” and “elements.” For consistency, this manual avoids using these similar terms. Finer-scale constituents that form a treatment are referred to as *materials* (i.e., plants, rocks, erosion matting). Similar terms found in other publications to describe *materials* include “components,” and “elements”. For consistency, we avoid the use of these similar terms throughout this manual.

Collectively, a combination of treatments constitutes a streambank bioengineering *project*. The goals that drive a particular streambank bioengineering *project* determine the analytical and design *approach* that a bioengineering practitioner may follow to address these goals.

As a final note, this document uses plant taxonomy as currently presented in the U. S. Department of Agriculture (USDA), Natural Resources Conservation Service (NRCS)’s PLANTS database (NRCS, 2016).

Form- v. Process-Based Approaches to Bioengineering

Analytical and design *approaches* to stream restoration and bank stabilization projects have been distinguished between those that are process-based and those that are form-based (Wohl, Lane and Wilcox, 2015). A process-based approach develops initial conditions that will allow the stream channel(s) and floodplains to evolve through fluvial processes and riparian succession toward more complex and dynamic habitats over time. In contrast, a form-based approach defines channel pattern, profile, and dimension, and uses structural features (such as rock vanes, toe wood, and riprap) to minimize channel adjustment.

In contrast, the use of a process-based approach has the advantage of allowing the stream and valley to adjust to fluxes in sediment and water inputs that occur due to changes in land use, wildfire, drought and flood, and climate change. This approach is beneficial on lands where little infrastructure exists in the floodplain, such that natural adjustments (i.e., sediment loads, channel meandering, and hydrology) over time can help satisfy ecological management priorities. A process-based approach may not be appropriate where infrastructure, residences, or agricultural lands may be impacted by natural channel and floodplain adjustments. In this scenario, a form-based approach may be most appropriate. A combined approach, where crucial characteristics of a desired channel are designed using a form-based approach, while other aspects of the stream and its floodplain are allowed to adjust and evolve over time, is also valid. Such an approach allows planners to better satisfy diverse project objectives.

Plant-based v. Structural-based Approaches to Bioengineering: a convenient division

Fripp, Hoag, and Moody (2008) note the imprecision of using the term “streambank soil bioengineering” to describe all treatments applied through the use of biological materials. Instead, they argue the practice of streambank bioengineering be divided into two general *approaches* based on their intended function, their ability to dynamically change over time, and the type of materials used: *plant-based bioengineering* and *structural-based bioengineering*. This manual uses these two classes of treatments, and uses the broader term *streambank bioengineering* when referring to the overall practice of applying plant- and structural-based treatments to address bank stabilization goals.

Fripp et al. (2008) argue that while the primary distinction between plant and structural treatments can be made based on function and materials, distinctions based on the anticipated behavior of the treatments during their design life are perhaps more significant. A plant-based treatment is flexible and dynamic, as it can recover fully following partial failure, allowing for continued streambank protection within the context of an ever-changing streambank. Additionally, plant-based treatments may be adaptively managed, as their ductile failure mode allows for continued stability as they re-establish themselves. In contrast, a structural-based treatment is designed to remain stable under greater erosive forces, and maintain a static bank. Once the design threshold is exceeded, however, the treatment typically fails catastrophically, requiring repair or replacement if continued erosion protection is required.

1.2 GOALS AND OBJECTIVES

An essential step in any stream project is the determination of project goals and objectives. Goals are general and are highly dependent upon context, while objectives are measurable and in support of the stated goals. Once goals are established, they are supported by one or more objectives describing how the goals will be attained. The stakeholders and technical specialists of a project base the perceived success or failure of a site upon thoughtful and consensus-based development of goals

and objectives. Further, because successful implementation of projects is dependent upon acceptance by those who live within and near the floodplain, the social context of the restoration project should be incorporated throughout the planning and design phases (Wohl, Lane and Wilcox, 2015).

The goals and objectives of a project should be defined during the scoping phase of the project. The perceived success or failure of many stream restoration projects can be as much a function of the appropriate scope of a project's goals, as the design and performance of the features. Thus, the importance of establishing achievable and well-defined project objectives is critical (NRCS, 2007).

Inclusion of ambiguous objectives, such as "fixing the stream", "stabilizing a bank", or "putting the creek back where it was" can lead to significant problems in the design process as well as make long-term monitoring and evaluation of project results difficult. Narrowing and refining project objectives reduces confusion for participants, and gives stakeholders clear and realistic expectations for the project.

SMART goal-setting

A popular and effective approach for goal-setting is the "SMART" framework (Doran, 1981). This approach underscores that project goals and objectives should be evaluated by stakeholders for compatibility with their individual interests, but also for the goals/objective's ability to be:

- ◆ *Specific* - Where, what, how, and when a result or activity is expected;
- ◆ *Measurable* - Establish metrics that indicate if, when, and where the objective is being met as related to form, function, or both;
- ◆ *Achievable* - Goals and objectives are achievable using known technologies or methods, or the team agrees to testing a new technology via a pilot project with realistic expectations for success;
- ◆ *Realistic* - The goal or objective does not include criteria like "never" or "always"; multiple goals are not competing or mutually exclusive; and the goal includes clear expectations and limits; and
- ◆ *Time-bound* - Specify the life span of the project, and performance criteria for the installation, establishment, mature, and aging phases of the work.

Table 1 provides examples of bank stabilization goals according to the SMART framework, adapted from multiple sources (NRCS, 2007; Kondolf, 2011). Column one lists the SMART criteria while column two provides a general goal associated with a fabricated bioengineering project. Subsequent rows include language that address the above goal- and objective-setting principles, reduce

ambiguity for the designer, create realistic expectations, and allow for effective monitoring and long-term evaluation.

| General Goal | Sample Language |
|--------------|--|
| Specific | <p>“Reduce lateral migration on river left between stations 25+30 and 27+85 for the purpose of maintaining farmlands on the adjacent property”</p> <p>OR</p> <p>“Limit recurring bank failures between stations 5+30 and 6+70, for the protection of the homes within the reach”</p> |
| Measurable | <p>“Reduce the loss of agricultural land due to lateral migration from 1% per year to 0.25% per year, given average flow conditions.</p> <p>OR</p> <p>“Reduce lateral bank movement from 10 feet per year to two feet per year, on average, over a 10 year performance period, excluding flood events over the 0.05 AEP”</p> |
| Achievable | <p>“Through a combination of structural measures such as wood deflectors and rootwads as well as willow stakes and container plants this project will reduce shear stresses on the vulnerable bank and increase bank cohesion via increased plant root bulb dimension”</p> |
| Realistic | <p>“This project is not expected to protect banks or property at events greater than a 20-year peak flow or for flows over 300 cfs lasting more than seven days, but will stabilize for low to moderate peak flows and short duration moderate to high flow events.”</p> |
| Time-bound | <p>“The project’s performance period is 10 years. Establishment of vegetation is expected to take three full growing seasons to achieve desired level of bank cohesion. Structural features may need replacement or significant maintenance after 10 years to account for changing river or watershed conditions”</p> |

Table 1: SMART decision-making framework for bank stabilization projects

Other example goals for bank stabilization and river restoration projects include: (a) protect bridge infrastructure; (b) reduce risk of flood inundation of specific values at risk; (c) restore fish and wildlife habitat, and (d) improve water quality.

Competing Goals

In certain cases, goals that initially appear to be competing will become compatible as stakeholders work through goal and objective refinement. Some instances of mutually supportive goals are:

- ◆ An interest to have channel stability at low to moderate flow events AND an interest to enhance aquatic habitat on some streams can be achieved through the use of large woody material
- ◆ A desire to have a river with seasonal floodplain or wetland habitat AND a desire to reduce erosive forces within the river channel can be achieved in some systems by using overflow or bypass channels and floodplain reconnections.

In some cases, a compromise must be reached when goals are found to be mutually exclusive. Such incompatibilities often occur when one goal is function-based and another is form-based. Some instances of incompatibilities are:

- ◆ An interest in having a river reach that can naturally evolve over time or rapidly change in response to large flow events AND an interest in the long-term stability of infrastructure that requires a fixed and static bank;
- ◆ A desire to have woody material within the reach to provide aquatic habitat benefits AND a desire to have a “clean” channel that does not pose unnecessary hazards to in-channel recreation.

Care must be taken during the goal and objective identification process to accurately determine if, when, and where goals are compatible or competing. Compromise between goals may only be necessary seasonally or at key points throughout the lifespan of the project, and/or in limited locations in the project area.

In summary, goals and objectives should be developed during the stakeholder engagement process, should be used to develop indicators of success, and are often invaluable during evaluation of “trade-offs” that arise during the design process.

Manual Organization

This introductory chapter places streambank bioengineering treatments within the context of river restoration practice at large. Chapter 2 presents a method for consideration and mitigation of risk in the design of streambank bioengineering projects. Concepts of stream mechanics and hydrology that are essential considerations for streambank bioengineering projects are presented in chapter 3. Concepts, design recommendations, and material considerations specific to *plant-based bioengineering* are presented in chapter 4, while chapter 5 provides details of individual plant-based bioengineering treatments. Design concepts and risk considerations specific to *structural-based*

bioengineering are presented in chapter 6. Chapter 7, in turn, details individual structural-based treatments. Chapter 8 addresses the integration of plant-based treatments into bank-stabilization structures. Management, monitoring, and maintenance are covered in chapter 9.

Disclaimer

While a diversity of bank stabilization designs should be considered during the planning phase, this manual addresses only those treatments pertaining to streambank bioengineering. Accordingly, the authors recommend each bioengineering treatment be assessed for its ability to fulfill its function within the context of the whole project, and that bioengineered treatments be applied only where they have a high probability of successfully providing the desired function.

Each treatment must be examined within the context of the entire floodplain, as design of any single treatment in isolation often results in undesired outcomes. As such, the authors recommend the treatments presented in this manual be applied as components within a well-integrated restoration plan.

It is important to understand that in most cases bioengineering treatments are not designed to withstand the same high magnitude design conditions as many traditional engineering treatments. Streambank bioengineering treatments are intended to provide a moderate level of bank stability, while facilitating ecological function, enhancing wildlife habitat, improving water quality, allowing for natural stream processes, and improving landscape aesthetics. The required level of confidence for a given streambank bioengineering treatment should be considered on a case-by-case basis. If a greater level of stability is required than can be provided by a bioengineered treatment, traditional engineering treatments must be relied upon. This manual presents many examples of incorporating bioengineering treatments into more traditional structural treatments in a way that reduces risk of failure. All drawings in this manual are concept only, and should not be used for specific construction projects. Finally, designers should seek research documents and engineering manuals for any necessary formulas for a given design project, and not utilize formulas presented in this manual.

2.0 DESIGN WITH RISK IN MIND

2.1 UNCERTAINTY IN RIVER RESTORATION AND STREAMBANK STABILIZATION PROJECTS

Evaluating probability, consequences, and uncertainty helps designers and stakeholders make informed design choices. This section outlines how to account for uncertainty in the project planning and design process, and addresses the evaluation, understanding, and mitigation of risk.

Uncertainty vs Risk

Risk is a measure of likelihood that an event or hazard will occur and an evaluation of the consequences of that potential event. Uncertainty identification is the acknowledgement that for every assumption, calculation, and evaluation throughout the development, implementation, and lifespan of a project, there are a suite of conditions that may exist or could develop that are different from the chosen or assumed condition. Uncertainty identification is a part of risk analysis, but risk analysis is significantly more than uncertainty identification.

The uncertainty identification process endeavors to define the “known unknowns” and to the greatest extent possible, the “unknown unknowns.” Uncertainty identification also institutes checks and balances throughout the design process, such that the influence of unknowns on the success or failure of a project is limited, quantified, or at minimum, acknowledged. The subsequent risk analysis incorporates this process into a synopsis of a project’s likelihood to succeed and the consequences if it does or does not.

Addressing Uncertainty in the River Restoration Process

Uncertainty is inherent to all river and bank protection projects. While uncertainty can be minimized through predictive modeling and appropriate design, it cannot be eliminated. Given the physical and ecological dynamics of river systems, the lack of long-term monitoring and performance data, and the variability of climate, the assumptions and outcomes of river restoration projects are uncertain (Wheaton, 2008). Historically, accounting for this uncertainty has often been ignored.

Adapted from Wheaton (2008), a four-step process is recommended to address uncertainty in river restoration and bank stabilization projects:

1. Identify the uncertainties in:
 - A. baseline and input data;
 - B. calculation methods (including their assumptions and sensitivity);

- C. construction materials, sources, and quality;
 - D. installation procedures; and
 - E. physical, geomorphic, and biological response of the system;
2. Explore the potential significance of each identified uncertainty (both in terms of negative impacts and positive outcomes);
 3. Identify and implement measures to detect the effects of each uncertainty in the design, construction, and monitoring phases of each project; and
 4. Effectively communicate each uncertainty and its significance to stakeholders, design, and construction teams.

This process, however, addresses only the uncertainties in variables and processes known to the project team, or the “known unknowns”. Despite the ability to draw on decades of experience and observation, scientific literature, monitoring data, and unfettered creativity, a host of unforeseen uncertainties or “unknown unknowns” will exist in each project. Accounting for and detecting these uncertainties is much more difficult. Given these inherent uncertainties, we recommend an adaptive management approach as it is well suited to allow practitioners and decision makers to adjust practices as new challenges unfold (Clark, 2002; Wheaton, 2008).

2.2 FAILURE RISK MITIGATION

Streambank bioengineering treatments most commonly fail during the most vulnerable periods following implementation. The four periods of maximum vulnerability of a streambank bioengineering treatment are:

- ◆ Immediately following construction, prior to full vegetation establishment;
- ◆ At the time of lowest annual water supply, including precipitation and natural subsurface irrigation (i.e., capillary fringe above water table);
- ◆ During high magnitude discharge events when the ability of the bioengineering treatment to stabilize the bank is overcome by the erosive force of the flowing water; and
- ◆ Over the long term, when the established vegetation has been succeeded by plant species that may not meet original design parameters (i.e., soil-binding characteristics).

Each of these failure mechanisms represent challenges and, at the same time, afford opportunities to use our knowledge of Colorado’s environments to increase the likelihood that plant materials will perform successfully. In the following section examples of each risk period is presented alongside the treatments that can be used to decrease each risks.

Note: The above maximum vulnerabilities do not represent the total vulnerability to a bioengineering project. Practitioners have witnessed a wide range of unexpected challenges that have undermined otherwise well-established sites. Examples that have set projects back or caused failure include an unplanned clearing (e.g., brush cutting, moving, tree felling, etc.), natural factors (e.g., beavers, plant disease), and others.

Post-Construction

Risk

The period immediately following construction is a critical time of risk because root systems of plants have yet to become fully established. In general, the capability of a bank to resist shear stress and unit stream power during the establishment period, and therefore withstand erosion, is substantially greater after three to four seasons than immediately after construction (Schiechl and Stern, 1997). The majority of the added resistance to erosion stems from the complex root networks that require sufficient time to develop. Chapters 3 and 4 outline the role of roots in bioengineering.

Opportunity

Several design considerations exist to decrease the window of vulnerable following construction of plant-based treatments. These approaches include:

- ◆ Proper species selection for the design conditions, and given the biotic and abiotic conditions of the site;
- ◆ Inclusion of a diverse site-adapted seed mix;
- ◆ Short-term surface erosion protection (i.e., erosion matting or geotextile);
- ◆ Tailoring soil amendments to the needs of the desired plant community and the current soil nutrient status;
- ◆ Accurate flow-frequency estimates; and
- ◆ Optimal timing of installation.
- ◆ Increasing soil moisture retention through improved soil organic matter content, and through use of mulch or erosion matting; and
- ◆ Providing supplemental irrigation.

In regards to developing a diverse seed mix, a suite of species should be selected that:

- ◆ Includes a mix of early- and late-seral species;
- ◆ Includes temporary cover such as sterile wheat hybrids (i.e., 'Quickguard' or 'Regreen', comprising no more than 5% of the seed mix); and
- ◆ Grows rapidly via subsequent seed spread or from rhizomatous root systems.

Decreasing the length of post-construction risk can also be attained by including multiple planting treatments such as seeding, container plants, and willow cuttings in the same site. The authors recommend the plants used for any restoration project be ecotypic to the site (i.e., they are locally sourced native species in regard to genetic origin).

Water is crucial to the success of all plant-based treatments. Water can be provided through precipitation, installing root balls to the depth of the capillary fringe above the water table, or supplemental irrigation. By tailoring seed mixes, plant palettes, and planting methods to account for the likely water sources available on a given site, desired species have a greater chance of performing their design function in a bank stabilization treatment. Chapter 4 provides additional recommended measures for improving revegetation success.

Lowest water table of the year

Risk

Often, the period when groundwater is at its lowest elevation co-occurs with the driest surface conditions of the year. In semi-arid climates such as Colorado's Front Range, dry periods can span multiple years. Confounding this challenge are upstream diversions, which can create "artificial" low-flow hydrologic regimes during drawdown periods. Thus, the risk to many plant-based treatments (i.e., dormant hardwood cuttings) arises during the lowest water table for a given year.

Opportunity

The most effective methods to enhance soil moisture for plant-based treatments following installation include:

- ◆ Ensure cuttings extend into the expected lowest water table for the site;
- ◆ Sow seeds in fall, late winter, or early spring—prior to the season of expected highest precipitation;
- ◆ Utilize soil amendments that increase water-holding capacity;
- ◆ Apply mulches or erosion matting that help retain soil moisture;
- ◆ Reduce water stress of vegetation (e.g., via transpiration of leaves) by adequately trimming excess foliage such as excessive leaf-bearing branches prior to plant installation; and
- ◆ Provide supplemental irrigation.

High Magnitude Discharge Events

Risk

A principle cause of streambank instability is insufficient vegetative cover, and a growing body of literature exists (Neary, Constantinescu, Bennett, and Diplas, 2013; Brooks & Brierley, 2012; Crosato & Saleh, 2010; Bertoldi, Gurnell, & Drake, 2011; and Li & Miller, 2010) highlighting the influence of vegetation on bank, channel, and floodplain stability. Root systems can reinforce bank material up to 20,000 times more than when such bank material lack vegetation (Knighton, 1998), with vegetative condition explaining much of the variability in bank erosion rates. Yet, as with traditional engineering treatments, high magnitude discharge events (quantified by shear stress and unit stream power) challenge the ability of a plant-based treatment to stabilize the bank. Failure mechanisms during high magnitude events can take several forms. The most common failures include:

- ◆ Bank scour;
- ◆ Undermining and mass wasting failure due to gravity; and
- ◆ Instability of a treatment relative to the forces applied to it.

Bioengineered treatments are normally designed to withstand floods of a relatively frequent recurrence interval. Typically, design events are on the order of 1.5 to 10 years, with the 25-year event becoming more common, and the 100-year storm occasionally being a consideration. However, as discussed above, the erosion potential of a particular flood event varies substantially as stream power changes. As was also noted, flood frequency poorly correlates with geomorphic instability. For example, lower-gradient streams with wide floodplains have significantly less unit stream power for a specific return interval flood than does a confined mountain channel at that same return interval. These varying conditions along a river induce varying risks to a given treatment used in multiple locations.

While it can be prudent to design for a larger discharge event, stability during such events is often achieved by more traditional engineering treatments, as bioengineering treatments can become unstable above certain threshold conditions. Accordingly, if the stability of a certain location (i.e., a bridge pier footing) is of paramount importance, then it is unlikely that bioengineering will be able to provide sufficient stability as compared to traditional engineering treatments. It should be noted that bioengineering treatments can be incorporated into almost all traditional engineering projects, imparting increased resistance and resilience to disturbance as well as improving ecological and biological benefits. Thus, designers are enabled to balance ecological function and relative needs for bank stability through bioengineering treatments appropriate for a given discharge event.

Opportunity

Bioengineering treatments capable of withstanding high magnitude events frequently share common traits. In Figure 1, the Federal Ministry of Agriculture and Forestry of Austria (Bundesministerium fuer

Land- und Forstwirtschaft, 1994) illustrates the influence of bank vegetation on flow. Due to the increase in local flow resistance caused by vegetation, there is an associated decrease in flow velocity in the region nearest the bank.

However, not all types of bank vegetation have similar effects. Unlike the stout vegetation depicted in the figure, newly planted, dead, poorly rooted, or poorly suited vegetation often does not decelerate flow and provide bank protection. Non-woody vegetation only minimally decelerates local flow, as it more readily lays down during high flows, as discussed above.

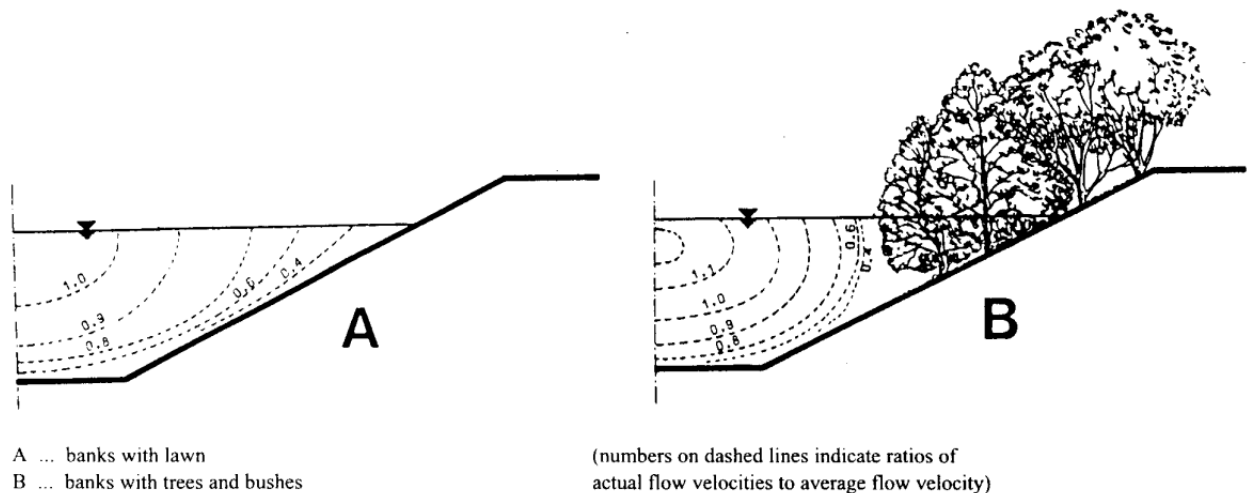

Figure 1: The interaction of channel velocities and bank vegetation (Reprinted with permission from Bundesministerium fuer Land- und Forstwirtschaft, 1994)

2.3 CONCLUDING REMARKS

Just as the risk of being hit by a car should not prevent someone from going to the grocery store, post-construction risks such as high flows, drought, grazing, etc. should not prevent the design from incorporating bioengineering treatments into bank stability and river restoration designs. Rather, recognizing the importance of living streambanks to residents, tourists, wildlife, and water quality, and with the knowledge that bioengineering treatments can provide stability under a wide range of discharge events, planners and designers have at their disposal adequate tools to meet multiple objectives defined and supported by stakeholders.

3.0 STREAM MECHANICS

The complex and interrelated nature of water, sediment, geology, vegetation, aquatic life in stream systems, as well as the social context influencing many of our streams, challenges practitioners to create conditions that satisfy multiple and sometimes conflicting objectives. Given these inherent complexities, comprehension of fundamental stream mechanics is necessary for identifying best approaches and avoiding potential pitfalls to completing a successful bioengineering project. An understanding of the basic mechanisms at work in river systems will inform the design process and ensure that bioengineered treatments are more likely to succeed. This chapter provides a foundation for selecting specific analysis and design approaches in the greater context of the site conditions, and project goals and objectives.

3.1 FUNDAMENTAL MECHANISMS

Sediment Transport

Stream sediments are subject to being transported downslope or downstream as the pull of gravity and the moving forces of water pull mountains down to the ocean. The size of the largest particles a stream can move under a given set of hydraulic conditions is referred to as *stream competence*. Typically, only very high flows are competent enough to move the largest sediments in a stream channel.

Traditional approaches for characterizing erosion potential fall within one of two categories: *maximum permissible velocity* and *shear stress*. The former approach is advantageous in that velocity is a parameter that can be measured within the flow. Shear stress cannot be measured directly, but must be computed from other flow parameters. However, since shear stress is a better measure of the fluid force on the channel boundary than is velocity, conventional guidelines, including American Society for Testing and Materials (ASTM) standards, rely on shear stress as a means of assessing the stability of erosion control materials.

Shear Stress

Shear stress develops at the interface between flowing water and materials forming the channel boundary (i.e., the streambank and bed). Shear stress (also called the *tractive force*) is the downstream component of the force on the riverbed and banks. The tractive force acts in the direction of the flow as it slides along the materials and creates lifting and drag coefficients that lead to erosion. *Critical shear stress* is the shear stress required to move a particle of a given size. Typically, the larger the particle the greater amount of shear stress needed to dislodge it and move it downstream.

When shear stress equals the critical shear stress, the channel will tend to be in equilibrium. Where shear stress is excessively greater than critical shear stress, particles will be moved by the flowing water and *erosion/degradation* may result. Where shear stress is less than critical shear stress, *channel aggradation* may result as particles deposit on the channel bottom and banks. Thus, the ability to calculate or measure both shear and critical shear stress is crucial in predicting channel adjustments and whether bioengineering treatments will be able to resist the force of water that will act on them.

Design methods for determining channel and bioengineering treatment stability in relation to shear stresses are numerous. Various equations and tables have been developed to predict the movement of materials in response to shear stress. These equations may focus on individual particles, uniform materials, non-uniform (mixed) materials, and/or cohesive materials (Kline, Alexander, Pytlik, Jaquith, & Pomeroy, 2007).

Sediment Load

Once dislodged, sediments may be transported one of two ways:

- ◆ *Wash load* – the smallest sediment particles that are held in suspension by turbulence; and
- ◆ *Bed load* – particles that roll, slide and skip along the streambed and are typically the size of sediments found on the streambed. These particles may become temporarily entrained into the wash load by turbulence during higher flows.

The total of wash load and bed load is the *sediment load* of a stream. Sediment transport rates can be computed using various equations, models, and field-derived empirical data beyond the scope of this manual.

Stream Power

Stream power quantifies the capacity of a stream to perform geomorphic work (i.e., transport of particles downstream). It is generally defined as the rate of energy dissipation against the bed and banks of a river, per unit downstream length. This energy dissipation is a result of the conversion of potential energy into kinetic energy as gravitational force pulls water downstream.

Kinetic energy is dissipated by *channel flow resistance*. Channel flow resistance occurs by:

- ◆ Bedload and suspended sediment transport;
- ◆ Hydraulic jumps; and
- ◆ The interaction of flowing water with the streambed and streambank materials, vegetation, instream wood, and other obstructions.

The main controls on stream power are slope, discharge and bed lithology.

Where excessive stream power exists, channel deformation and erosion occur (to the extent bed materials allow) to balance the energy. Where insufficient stream power exists to move the stream's sediment load, sediment deposition occurs.

Stream power is commonly considered from two perspectives: *total stream power* for a given reach, and *unit stream power*, which normalizes the stream power as a function of channel and floodplain width.

Total Stream Power

Total stream power is computed as:

$$\Omega = \rho g Q S$$

where Ω is the stream power, ρ is the *density* of water (lb/ft³), g is acceleration due to gravity (32.174 ft/s²), Q is discharge (ft³/s), and S is the channel slope. The derivation of this equation assumes a rectangular cross-sectional area; that water surface slope, energy grade line slope, and bed slope are approximately equal; and that $\sin(\alpha) = \tan(\alpha) = \text{slope}$, which is valid only for slopes less than 0.1.

Stream power laws describe a channel's ability to transport sediment, thus its potential to incise, widen, aggrade, or adjust its *planform* (i.e., plan-view shape). In general, high stream power values correspond with steep, straight, scoured reaches, and bedrock gorges; low stream power values occur in broad alluvial flats, floodplains, and basins. The spatial distribution of stream power along a channel has been linked to river form, erosion hazard potential, and flood-response behavior (Bagnold, 1966, 1980; Graf, 1983; Magilligan, 1992; Lecce, 1997; Knighton, 1999; Flores, Bledsoe, Cuhaciyan, & Wall, 2006).

Since slope exerts strong control on stream power, and many factors can affect the local slope of a channel, stream power can vary substantially from reach to reach (Fonstad, 2003; Reinfelds, Cohen, Batten & Brierley, 2004; Jain, Preston, Fryirs, & Brierley, 2006; Hack, 1973). Changing the channel slope (i.e., through reducing or increasing its sinuosity) and boundary resistance (i.e., through bank revegetation or other roughness features) will have consequential effects on the stream's erosive power. Consequently, modifying stream channel slope and bank roughness are important methods for reducing the potential for streambed degradation and streambank erosion.

Unit Stream Power

Unit stream power is an important function in many models of landscape evolution and river incision. *Unit stream power* (ω ; measured as Watt/m² or lb/sqft), is stream power per unit channel width (b), and is given by the equation:

$$\omega = \frac{\rho g Q S}{b}$$

The derivation of this equation assumes a rectangular cross-sectional area; that water surface slope, energy grade line slope, and bed slope are approximately equal; and that $\sin(\alpha) = \tan(\alpha) = \text{slope}$, which is valid only for slopes less than 0.1. Unit stream power is used in the study of river channel migration and can be applied to sediment transport (Bagnold, 1966). Ongoing work shows the importance of ω in single events and at geologic time scales. Studies have shown that at-a-point magnitudes of ω predict:

- ◆ Locations of extreme geomorphic changes in floods (Magilligan, 1992; Buraas, Renshaw, Magilligan, & Dade, 2014);
- ◆ Stream bed grain size (Snyder, Nesheim, Wilkins, & Edmonds, 2013);
- ◆ Abundance of landslides (Larsen & Montgomery 2012); and
- ◆ Bedrock incision rates (Dietrich et al. 2003; Ouimet, Whipple, & Granger, 2009).

Stream power, like shear stress, can be computed manually using directly measured field data, or through computational models. Field data collection methods and models for computation of these and other flow parameters valuable in designing stream projects are presented in Yochum (2015). It is important to note that manual computations and the results of 1-D models (such as HEC-RAS) are reach-average values while, in actuality, certain portions of that cross section will experience higher and lower shear stresses and unit stream power than these average values.

3.2 LANE'S BALANCE

Predicting stream behavior is particularly useful in stream systems that have been significantly altered by natural process or by design. The relationship between water in a stream and its ability to transport sediment (shear stress and stream power) has been visually represented by the Lane's Scale (Lane & Borland, 1954). The driving variables in Lane's stability concept include:

- ◆ Sediment size;
- ◆ Sediment quantity (i.e. load);
- ◆ Stream slope; and
- ◆ Water quantity (i.e. discharge).

When any one or more of the variables of this scale change, the system will adjust out of equilibrium and aggradation or degradation of the bed and banks may occur (Figure 2). Given enough flow and unconfined space, a stream will adjust its slope and sediment transport capability back towards an

equilibrium (balanced) condition. This equilibrium will be reached relative to the sediment supply and size, valley slope, and discharge (i.e., it's "most probable form" as described by Leopold, 2006).

Although simplistic, the fundamental principle behind the balance is sound. Implicit within the figure are the following:

- ◆ If the ability to transport sediment is equal to the rate and caliber of sediment delivered to that location, then channel morphology should remain stable, although the location of the channel and its habitat features (i.e., bedform) may remain dynamic;
- ◆ Excess sediments delivered to a reach may lead to instability, caused by aggradation of soil, cobble, rock, and other materials;
- ◆ Conversely, excessive reduction of sediments by way of streambank armoring, sediment barriers such as undersized bridges and crossings, large-scale watershed changes, and urbanization may lead to degradation;
- ◆ Changes in stream discharge quantity (i.e., due to such mechanisms as stream diversions, flow augmentation, excessive stormwater inputs, or wildfire) can tip the balance, and sediment erosion or aggradation may occur.

This concept is a valuable reminder of the potential repercussions that can result from changes in fundamental stream characteristics.

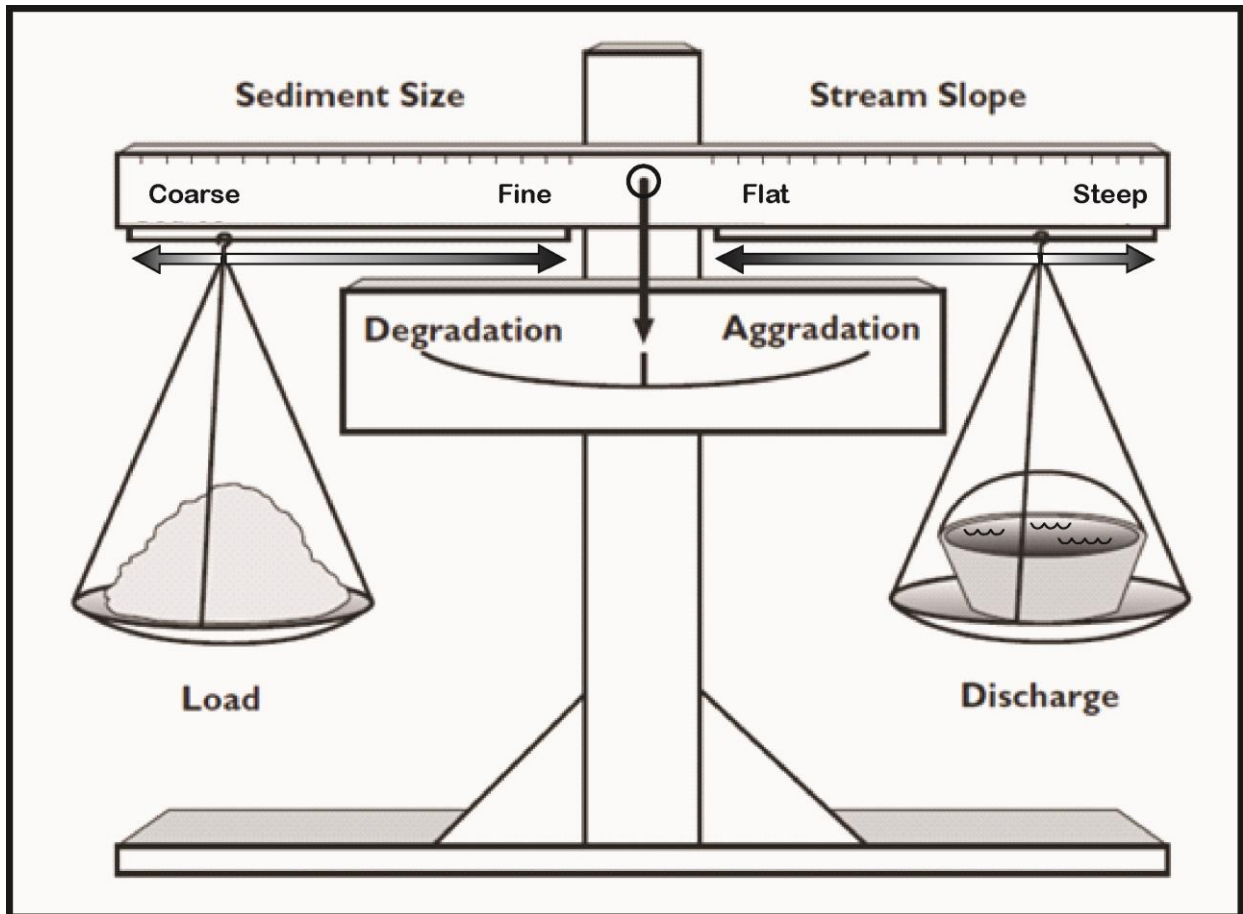

Figure 2: Lane's Balance (Adapted from WDFW, 2003)

3.3 CHANNEL AND FLOODPLAIN PROCESSES

Geomorphic processes are the primary mechanisms for forming channel and floodplain shapes (i.e., width, depth, meanders, terraces, bedform features, etc.) through erosion, transport and deposition of sediments by streamflow. Understanding these processes and how they combine to form stable stream channels, or how they might conspire to create instability, is necessary for assessing, designing, and applying bioengineering treatments.

Channel Type

The interaction of flows and sediment loads with the channel boundary should be used in the selection of the appropriate design approach. Channels can be divided into two general categories based on their sediment load and the stability of the channel boundary during normal flow: *threshold channels* and *alluvial channels*. The following descriptions of threshold and alluvial channels are provided by NRCS's NEH Part 654, Chapter 7 (NRCS, 2007). It should be noted that transitional stages between these channel types do exist (e.g., there is not always a sharp demarcation between the two categories).

Threshold Channels

A *threshold channel* is a channel in which channel boundary material has no significant movement during the design flow. The term *threshold* is used because the channel geometry is designed such that applied forces from the flow are below the threshold for movement of the boundary material.

A threshold channel can be naturally occurring, as in cases where the bed is composed of very coarse material or erosion-resistant bedrock. Streams where the boundary materials are remnants of processes that are no longer active in the stream system, such as those formed by high runoff during the recession of glaciers, may also be threshold streams. Streams that have become armored as result of reduced upstream sediment supply would also qualify as threshold.

Fine sediment may pass through threshold streams as throughput or wash load. Generally, wash load should not be considered part of the bed-material or sediment load for stability design purposes even if there are temporary deposits on the streambed at low flow. However, excessive “throughput” or wash load may impair water quality and cause other environmental degradation.

Unlike alluvial channels, threshold channels do not have the ability to quickly adjust their geometry. This is because the material forming the channel boundary of threshold channels is not erodible within the normal range of flows, and there is no significant exchange between the sediment being transported and the sediment that forms the bed and banks. At flows larger than the design flow or during extreme events, threshold channels may become destabilized for short periods. Since threshold channels do not adjust their dimensions to the natural runoff hydrograph, the concept of channel-forming discharge is generally not applicable.

Alluvial channels

Alluvial streams and channels have bed and banks formed of material transported by the stream under present flow conditions. There is an exchange of material between the inflowing sediment load and the bed and banks of the stream. There is an exchange of material between the inflowing sediment load and the bed and banks of the stream. In an alluvial channel, the bed and banks of the channel are composed of unconsolidated sediment particles and, as such, there is continual exchange of the channel boundary material with the flow. In contrast, the exchange of bed and bank material in a threshold channel is limited or nonexistent for stresses at or below the design flow condition (NRCS 2007). Since alluvial channels adjust their width, depth, slope, and planform in response to changes in water or sediment discharge, an alluvial channel will not be as static in the landscape as a threshold channel.

Channel Stability

An analysis of channel stability should be conducted prior to installation of streambank bioengineering measures. An alluvial stream is described as stable when it has the ability to pass the incoming sediment load without significant degradation or aggradation, and when its width, depth, and slope

are relatively consistent over time. In light of this, bank erosion and bankline migration are natural processes and may continue in a stable channel over time. When bankline migration is deemed unacceptable (i.e., where bridge, road embankments and other infrastructure are at risk), then engineering, and where appropriate bioengineering solutions, must be employed that attempt to prevent bank erosion at the chosen design flow(s).

Degrading channels commonly undermine cutoff walls, other flow-control structures, and bank protection. Bank sloughing due to degradation often greatly increases the amount of debris carried by the stream and increases the downstream potential for blocked waterway openings, reduced conveyance, and increased scour at bridges. Aggradation within a stream channel increases the frequency of flooding and overbank sedimentation which can, in turn, lead to failure of a bioengineering project.

Long-term bed elevation changes may be the natural trend of the stream or may be the result of modification to the stream or watershed. The streambed may be aggrading, degrading, or in relative equilibrium in the vicinity of a planned bank protection project. Long-term aggradation and degradation do not include the cutting and filling of the streambed at a site that might occur during a runoff event. A stream may cut and fill at specific locations during a runoff event and also have a long-term trend of an increase or decrease in bed elevation over a reach.

Another challenge to designing streambank protection measures is providing an accurate estimate of the long-term bed elevation changes that will occur during the life of the planned treatment. Long-term trends may change during the life of a project as result of natural or human-caused stream or watershed modifications. Factors that affect long-term bed elevation changes include:

- ◆ Dams and reservoirs (upstream or downstream of a study reach);
- ◆ Changes in watershed land use (urbanization, deforestation, etc.);
- ◆ Channelization;
- ◆ Cutoffs of meander bends (natural or of human origin);
- ◆ Changes in the downstream channel base level (control);
- ◆ Gravel mining from the stream bed;
- ◆ Diversion of water into or out of the stream;
- ◆ Natural lowering of the fluvial system; and
- ◆ Movement of a bend with respect to stream planform, resulting in a change in length and therefore slope of a channel.

Bed elevation of tributary streams will follow the trend of the larger stream unless there are grade controls in place. *Grade controls* could be bedrock, dams, culverts, check dams, or other structures that control the grade of a stream at a specific point.

Data from the United States Army Corps of Engineers (USACE), United States Geological Survey (USGS), and other Federal and state agencies should be considered when evaluating long-term streambed variations. If no data exist or if such data requires further evaluation, an assessment of long-term streambed elevation changes for rivers should be made using the principles of river mechanics. Such an assessment requires the consideration of all influences upon the study reach, i.e., runoff from the watershed to a stream (hydrology), sediment delivery to the channel (watershed erosion), sediment transport capacity of a stream (hydraulics), and response of a stream to these factors (geomorphology and river mechanics).

Channel Evolution

Geomorphologists have historically concerned themselves with documenting and explaining the changing morphology of the landscape over geologic time. The nature of landform evolution informs the designer that change at the local level (i.e., hillslopes, channels, etc.) can be sufficiently rapid to cause problems with the design and maintenance of stream bank protection measures. One of the key factors recommended for the selection and design of a given treatment is to determine if the channel is vertically stable. If the channel is unstable, it is important to determine the *channel evolution stage* for the reach of interest. These determinations can be made during a field site visit of an existing plant-based treatment, or during the reconnaissance phase of a project.

The channel evolution model (CEM) sequence shown in Figure 3 describes a systematic response of a channel to streambed lowering (i.e., incision) and encompasses conditions that range from disequilibrium to a new state of dynamic equilibrium. Variables used within this diagram include h , which corresponds to *bank height*, and h_{crit} , which corresponds to *critical bank height*. *Critical bank height* is the height at which the bank is no longer geotechnically stable. Stages C and D in Figure 3 illustrate the widening (through bank failure and bank retreat) that typically follows incision. These stages are only conceptual and variations may be encountered in the field. However, the sequence assists with determining the trajectory of a stream channel based on empirical field data that characterizes channel forms and active channel processes. The hydraulic, geotechnical, and sediment transport characteristics of a reach can also be correlated based on knowledge of the channel evolution stage (Garcia, 2008). Due to climatic differences, the evolutionary response to channel change may take decades or even centuries to adjust.

Cluer and Thorne (2014) have updated the earlier models and proposed a Stream Evolution Model that includes a precursor stage (labeled as stage “0”). Their model recognizes that streams may naturally be multi-threaded prior to disturbance, and represents stream evolution as an adaptive phenomenon, rather than a linear phenomenon. Their Stream Evolution Model recognizes an

evolutionary cycle exists, within which streams advance through the common sequence, skip some stages entirely, recover to a previous stage, or even repeat parts of the evolutionary cycle (Cluer and Thorne 2014). The Stream Evolution Model, with its interpretation of habitat and ecosystem benefits, improves river management decision making for aquatic, riparian and floodplain conservation and restoration.

Although applicable only to incised channels, the model put forward by Schumm, Harvey, and Watson (1984) and similar evolution models are of value in developing an understanding of channel dynamics and in characterizing reach stability. Harvey and Watson (1986) and Simon and Hupp (1986, March) further refined the Schumm et al. (1984) model for incised channels in the southeast U.S. while Thorne (1999) added a later stage of channel evolution. Elliott (1979), Gellis (1988), and Elliott, Gellis, and Aby (1999) developed CEMs for dryland channels in the southwest, and Hawley, Bledsoe, Stein, and Haines (2012) developed a CEM that qualitatively describes morphologic responses of semi-arid channels to altered hydrologic and sediment regimes associated with urbanization (hydromodification).

Assessment treatments for identifying and determining the stage and trajectory of channel evolution are beyond the scope of this manual. NRCS's NEH Part 654, TS3A provides guidance for the selection of appropriate inventory and assessments to determine stream corridor conditions.

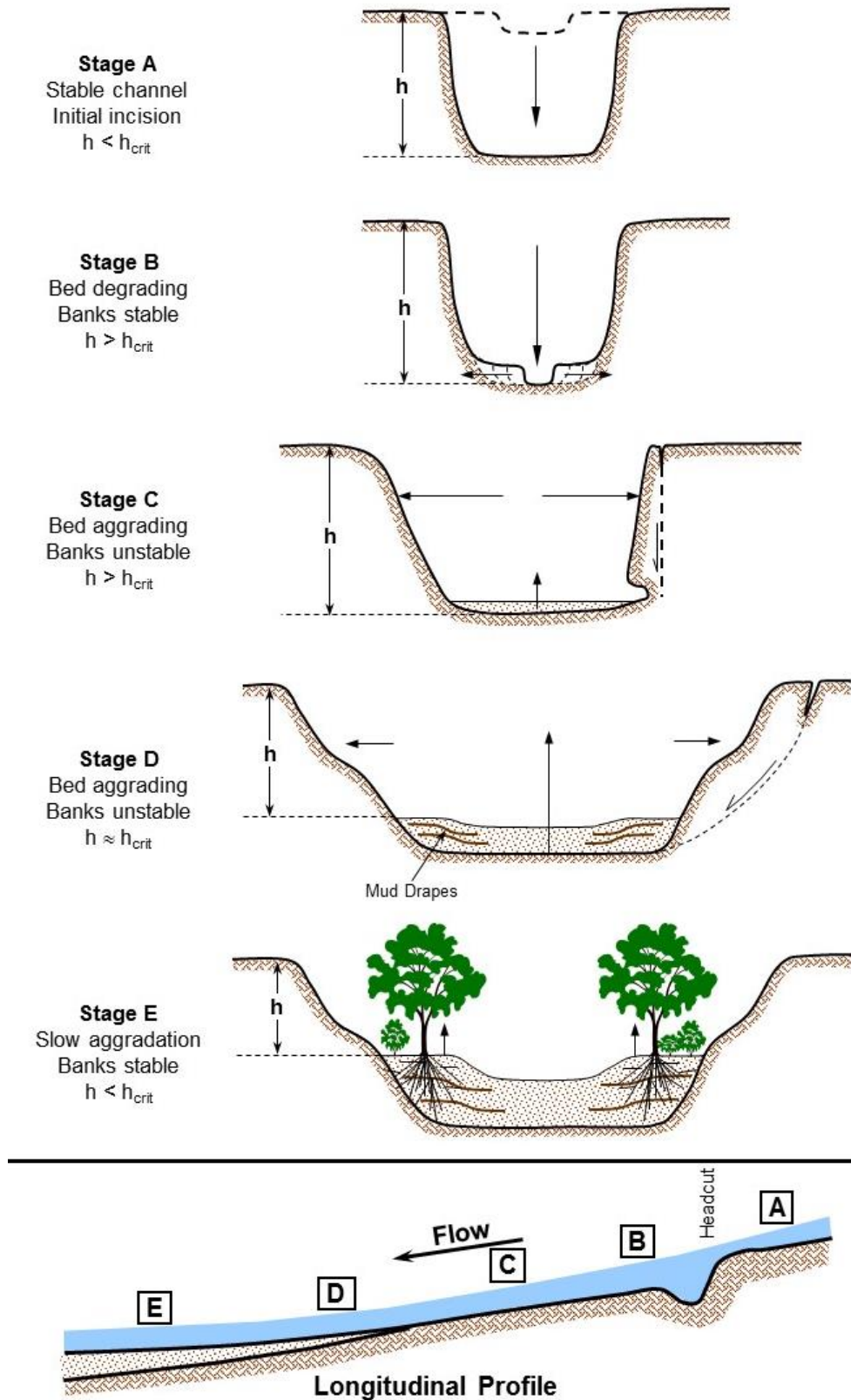

Figure 3. Channel evolution model (CEM) of Schumm, Harvey, and Watson. h = bank height; h_{crit} = critical bank height. (1984; Adapted with permission)

Channel Flow Resistance

The problem of determining the flow velocity (which relates to treatment selection to resist shear stress and stream power as previously mentioned), and flow depth (which relates to plant selection and placement as well as treatment type) in a channel, for a known discharge, remains a difficult challenge for bioengineers. One of the principal causes is the difficulty in determining accurately flow-resistance coefficients. Among the diverse and complex phenomena influencing resistance are turbulence, boundary roughness, and channel features such as discrete obstacles, bars, channel curvature, recirculation areas, secondary circulation, etc. The presence of bedload is also known to have direct impact on flow resistance (Simões, 2010). The following section provides a general overview on the topic of open flow resistance and resistance equations for use in bioengineering design.

Flow resistance in open channels is composed of three fundamental components:

- ◆ *Boundary resistance;*
- ◆ Internal distortion or form resistance, from a deflection that causes super elevated and depressed water surfaces, resulting in secondary currents and eddying (i.e., turbulence); and
- ◆ Impact or spill resistance (resulting from sudden flow deceleration from *supercritical flow*, such as at the base of a waterfall).

For the purposes of this manual, we are primarily concerned with boundary resistance. Boundary resistance occurs as a result of bed and bank grain material, bedforms such as dunes and step pools, planform, vegetation, instream wood, and anthropogenic obstructions (i.e., engineered structures). Bioengineering practices typically increase boundary resistance by the following methods:

- ◆ Intentionally-planted streambank vegetation that increases secondary currents in the near-bank zone, and
- ◆ Structural materials (i.e., large wood) that introduce secondary currents and localized flow transitions.

Manning's Equation

Manning's n is the most common resistance coefficient used in the United States. Other resistance coefficients include Darcy Weisbach's f and Chezy's C .

The Manning's equation is expressed as:

$$V = \frac{kR^{2/3}S_f^{1/2}}{n}$$

where R , the hydraulic radius (m or ft), is expressed as

$$R = \frac{A}{P_w}$$

and V is the average cross-sectional velocity (m/s or ft/s), k is a conversion factor equivalent to 1.00 in the SI unit system and 1.49 in the English unit system, S_f is the friction slope (m/m or ft/ft), A is the cross-sectional area (m² or ft²), and P_w is the wetted perimeter (m or ft).

Prediction

Flow resistance prediction is inexact, with varying results often obtained by different methodologies and practitioners. However, the importance of obtaining accurate resistance coefficients is understood when one realizes an inaccurate coefficient will result in an inaccurate prediction of flow velocities and inaccurate design parameters. Experience is fundamental for the selection of the most appropriate resistance coefficient, which should be selected for the design discharge of interest. To address potential variability, multiple resistance calculation methods should be used, and the results compared for consistency. Three steps are recommended when predicting flow resistance for applications such as 1-dimensional modeling:

1. Consult a general guide that provides a range of potential resistance values (Brunner, 2010; NRCS, 2007; Fischenich, 2000; Arcement & Schneider, 1989), to develop an understanding of a reasonable range in Manning's n given the particular setting;
2. Utilize photographic guidance (Barnes, 1967; Aldridge & Garrett, 1973; Hicks & Mason, 1998; Yochum, Comiti, Wohl, David, & Mao, 2014); and
3. Apply a quantitative prediction methodology:
 - a. Implement a quantitative prediction method appropriate for a given stream type (see below); or
 - b. Implement a quasi-quantitative approach (Cowan, 1956; Arcement & Schneider, 1989).

The inclusion of quantitative prediction methods is important to reduce bias. In low-gradient streams (clay-, silt-, and sand-bed channels), bedforms need to be predicted for the hydraulic conditions using guidance such as Brownlie (1983). Flow resistance varies by bedform type, as indicated in Table 2. In mid-gradient channels (slopes approximately between 0.2% and 2%, gravel- and cobble-bed, riffle-

pool and plane bed channels), Bathurst (1985), Jarrett (1984), Hey (1979), and Limerinos (1970) are valuable for quantitative n prediction using relative grain submergence (i.e., bed material size divided by a depth term). In high-gradient channels (i.e., slopes greater than 2%, cobble- and boulder-bed, step pool and cascade channels), relative bedform submergence—bedform variability divided by a depth term—can be most accurate for n prediction (Yochum, Bledsoe, David, & Wohl, 2012). However, n predicted by Jarrett (1984) can be accurate in channels within the limits of the dataset used in its development (i.e., a channel < 3.4% gradient).

| Flow condition | Bedform type | Flow resistance (Manning's n) |
|----------------|----------------|----------------------------------|
| Subcritical | Plane bed | 0.012 - 0.014 |
| Subcritical | Ripples | 0.018 - 0.03 |
| Subcritical | Dunes | 0.02 - 0.04 |
| Transitional | Plane Bed | 0.01 - 0.013 |
| Supercritical | Antidune | 0.012 - 0.020 |
| Supercritical | Chutes / pools | 0.018 - 0.035 |

Table 2: Manning's n in sand-bed channels. Adapted from Richardson et al (2001).

While substantial amounts of large dead woody debris historically accumulated in many Colorado stream reaches, many of our streams are currently devoid of such woody debris, with commensurate decreases in flow resistance. Improper woody debris and riparian vegetation management (i.e., substantial reduction of woody vegetation in the riparian area) actions may induce a negative feedback loop, where changes in in-channel flow depth may lead to increased shear stress and greater potential for vegetation loss due to subsequent erosional processes.

In contrast, floodplains containing large amounts of vegetation should experience substantial increased flow resistance for overbank flows and provide regular inputs of woody material. In the absence of vegetation, the channel bed material of low gradient streams, and the bedform of steeper gradient streams, drive the selection of the appropriate Manning's n . Where the stream is sufficiently narrow such that bank vegetation dominates the channel cross-section (or dominates the floodplain at the flow stage of interest), Manning's n values established for dominant vegetation types may be most appropriate (Thomsen and Hjalmarsen, 1991).

The designer should utilize a detailed onsite assessment to classify sub-reaches within the project reach based on vegetation type, extent, and density (or, alternatively, bed material composition and bedforms) in order to assign appropriate n values. When bioengineering measures are evaluated for applicability, the designer should correlate the vegetation composition and density of the proposed measures to those of existing vegetation.

While the contribution of vegetation to flow resistance is known to be an important component in many streams, there are few vegetation roughness estimates available. Plant structures are challenging to describe numerically because of their myriad shapes, seasonal variability in structure, and the shifting mosaic of their occurrence along floodplains. The magnitude of the roughness coefficient depends primarily on the density and stiffness of the plant structures. The degree to which vegetation affects flow depends on the depth of flow relative to vegetation height, the percentage of flow obstructed by vegetation, the degree to which vegetation is affected or flattened by high flows, and the alignment of vegetation relative to the flow (Phillips, McDaniel, Capesius, & Asquith, 1998).

A conundrum for bioengineering practitioners is that higher density and maturity of wetland and riparian vegetation results in higher n values, lower velocities, higher water surface elevations, and higher reach average shear stress. Therefore, the more effective we are at preserving, restoring, or enhancing native wetland and riparian vegetation, the more challenging it becomes to simulate reach-average shear stress without exceeding the permissible values for the applicable vegetation. Part of this conundrum is due to simplified assumptions in the shear stress equation. Utilization of 2-D hydraulic modeling can assess variation in shear stress laterally across a channel and floodplain, hence providing greater understanding of this problem.

Stream Capacity

Stream capacity is the sum of in-channel capacity plus floodplain capacity at the flow stage of interest. In-channel capacity can change over time as bankfull channels adjust to variations in flow regimes induced by irrigation withdrawals and inter-basin diversions, stormwater input, and climate variability and change. With reduced flows, channels can have reduced cross section area and increased flow resistance over time, with encroaching sediment deposition and streambank woody vegetation growth. Within the floodplain, capacity is often decreased by vegetation growth and roadway embankment encroachment. Conversely, increased flow inputs can widen channel cross-sections and remove bank materials and the vegetation that was once there. Feedback loops between these mechanisms exist, further complicating situations when viewed from a reach perspective. The potential change in stream capacity in both the floodplain and channel due to increased flow resistance should be a consideration in project planning and design.

Lay-down of Vegetation

The relative “stiffness” of plant structure within the channel affects the magnitude of the roughness coefficient, which in turn, affects flow velocity and pattern as well as channel capacity. In general, some categories of plants (i.e., herbaceous vegetation) are less stiff than others (i.e., woody vegetation).

We know, however, from observation that willows such as sandbar willow (*Salix exigua*) and some other riparian vegetation are flexible such that they lay over as flow velocity and depth increase, empirically indicating lower n values with increasing flow. This natural flexibility allows highly

rhizomatous willow species, such as sandbar willow, to thrive on sandbars, streambanks, and floodplains under a range of flow conditions. Thus, it follows that natural vegetation can provide channel and bank stability over a wider range of conditions than typically cited in the literature (Arcement & Schneider, 1989; Phillips & Tadayan, 2006). Accordingly, a range of n values based on flow regime should be applied rather than one “static” n value, when modeling channels dominated by native vegetation. For additional information on this subject, the reader should refer to Chen et al. (1999), who performed flume tests on sandbar willow and other riparian species to assess their behavior with respect to bending, and possible failure, and possible soil movement/loss corresponding to variable flow regimes. The study results indicate N values for native plant canopies are a function of plant characteristics (i.e., plant species and time of the year) and the Reynolds number (i.e., flow velocity and flow depth).

The time of year plays into the range of N values as well, as willow stems are full of leaves during the growing season and devoid of leaves in the dormant season. For example, Manning's N coefficients for sandbar willow ranged from a low-flow value of 0.0548 to a high-flow value of 0.0297 in March (before leaf emergence); from 0.0722 to 0.0512 in April (at the onset of leaf emergence); and from 0.0735 to 0.0536 in May (with full leaf emergence). This study also indicates that native vegetation protects the soil surface from the erosive effect of high velocity river flows when compared to a bare soil surface.

Jarvela (2002) performed a similar flume study, the results of which support the findings of Chen et al. (1999) and show large variations in the friction factor, with depth of flow, velocity, Reynolds number, and vegetation density. The maximum values for the friction factor were obtained when the Reynolds number or the flow velocity were at their lowest. The Reynolds number, however, alone was insufficient to explain the resistance. The friction factor was most dependent on:

- ◆ Relative roughness in the case of grasses;
- ◆ Flow velocity in the case of willows and sedges/grasses combined; and
- ◆ Flow depth in the case of leafless willows on bare bottom soil.

Streambank stabilization and restoration projects often involve significant modification to the banks. Designers of bank stabilization or restoration projects must ensure that the materials placed on the banks will be stable for the full range of conditions expected during the design life of the project. Unfortunately, treatments to characterize stability thresholds are limited. Fischenich (2001) noted that theoretical approaches did not exist then and empirical data for shear stress or stream power were generally lacking and mainly consisted of velocity limits, which are of limited value. Fischenich (2001) further notes that shear thresholds for soils found in channel beds and banks are quite low (generally < 0.25 lb/sf), while those for vegetated soils (0.5 – 4 lb/sf), erosion control materials and bioengineering treatments (0.5 – 8 lb/sf), and hard armoring (< 13 lb/sf) offer enhanced stability.

3.4 STREAMBANK CHARACTERISTICS

Bank Material

Bank angle and streambank resistance to erosion is closely related to several characteristics of the bank material. Bank material can be broadly classified as cohesive, non-cohesive, or composite. Banks consisting of *Non-cohesive* (i.e., sand, cobble, and boulder materials not influenced by electrostatic bonds between particles) materials are highly susceptible to undercutting and bed degradation, as bank material tends to be removed grain by grain by flowing water. The rate of particle removal and, hence, the rate of bank erosion is affected by factors such as particle size, bank slope, the direction and magnitude of stream velocity adjacent to the bank, turbulent velocity fluctuations, the magnitude of and fluctuations in the shear stress exerted on the banks, seepage force, piping, and wave forces.

Banks composed of *Cohesive* materials (i.e., largely composed of silt and sand-sized material) are more resistant to surface erosion. Electrostatic forces between particles allow cohesive soil to form vertical or near vertical banks. Such banks may be susceptible to erosion such as toe scour, cantilever failure, and mass wasting for bank heights taller than the critical bank height (Terzaghi, 1943). Cohesive banks have low permeability, which reduces the effects of seepage, piping, frost heaving, and subsurface flow on bank stability.

Composite (i.e., stratified) banks consist of layers of materials of various sizes, permeability, and cohesion. The layers of non-cohesive material are subject to surface erosion, but may be partly protected by adjacent layers of cohesive material. This type of bank is also vulnerable to erosion and sliding as a consequence of subsurface flows and piping.

Bank Retreat

The erosion, instability, and/or retreat of a streambank is dependent on the processes responsible for bank erosion and the mechanisms of failure resulting from the instability created by those processes. Bank retreat is often a combination of these processes and mechanisms varying at seasonal and sub-seasonal timescales. Bank retreat processes can be grouped into three categories: weakening and weathering processes, direct fluvial entrainment, and mass failure. The impact of these processes on bank retreat is dependent on site characteristics, especially near-bank hydraulic conditions, bank height, and the geotechnical properties of the bank material.

As previously indicated, the stability of the bank with respect to mass failure is dependent on soil properties and bank geometry. Bed lowering and lateral erosion are the two most common processes that act to steepen the bank and cause bank instability. For estimating critical bank height for steep, cohesive banks, a simple slope stability analysis can be developed. Refer to the approach derived by Thorne and Osman (1988) to predict bank stability response to lateral erosion and bed degradation.

Similarly, Simon, Curini, Darby, & Langendoen (1999) provided a detailed discussion on streambank mechanics and the role of bank and near-bank processes in incised channels.

Thorne and Osman (1988) also developed a modeling treatment to study the effects of channel widening and bank sediment contribution on flow energy, stream power, and the rate and extent of bed lowering during degradation. They demonstrated how scour depth at the outer bank may be limited by the critical bank height. If scouring causes the outer bank to fail, then the channel will tend to migrate laterally rather than incise. Their analysis treatment can be used to predict the equilibrium cross section and migration rate incorporating bank stability considerations. It can also be used to predict the likely increase in scour depth resulting from outer bank stabilization in a bendway. The reader is guided to the Thorne and Osman (1988) information prior to evaluating lateral erosion and bank instability problems for a given site.

Bank Angle

Specific design guidance for bank angles relative to different vegetation types, establishment, and persistence is limited. Bank angle is often defined as H:V which is the ratio of Horizontal to Vertical distance. Lagasse et al. (in press) notes that stable banks with very slow erosion rates tend to be slopes of less than about 30 percent (3H:1V), whereas unstable banks with moderate to high erosion rates usually have slopes which exceed 30 percent and rarely have a cover of woody vegetation.

Work conducted by Bowie (1982) in Mississippi indicates the bank must be pre-shaped to work properly, and slopes no steeper than 2H:1V are typically required for successful plant establishment. Schiechl and Stern (1997) recommend that streambank slopes should not exceed 3H:1V, and only in exceptional cases approach 2H:1V or 3H:2V. Where structural-based treatments are used in conjunction with plant-based treatments, it is recommended that the structural treatments be placed on slopes no steeper than 1.5H:1V or flatter. The recommended maximum slope for most riprap placement is 2H:1V. Most rock cannot be stacked on a bank steeper than 1.5H:1V and remain in place permanently. In contrast, alternative treatments such as gabion baskets, stacked boulders, and vegetated geogrids are well suited to steep banks.

Based on the literature and experience, bank angles in the range of 2H:1V to 3H:1V appear appropriate for plant-based bioengineering treatments, depending on the treatments used and how well treatments are applied. It should be noted that a geotechnical embankment or slope stability analysis may be required depending on the bank material composition, and may ultimately impose a limit on the design slope. Further reading on these topics can be found below and in Chapter 5.

Soil Properties and Geotechnical Stability

Streambank bioengineering measures increase stream roughness and slow the water velocity near the slope face. They also armor and reinforce the surface soils. However, some problems with instability and excessive erosion of streambanks are not readily solved by bioengineering treatments

alone. Problems involving rotational failures of streambanks, piping (sapping) of bank soils, and shallow slides in highly plastic soils are difficult to solve using only bioengineering treatments. Erosion on streambanks in highly dispersive clay soils also cannot be solved with soil bioengineering measures alone. If appropriate remedial solutions are to be designed, engineers and planners must recognize and understand special instability problems that have underlying geotechnical causes.

Analyzing bank slopes for geotechnical stability requires an understanding of a complex system of forces. Evaluating how to protect streambank soils from the erosive forces of flowing water frequently is only part of the task. Even if banks are protected from the erosive forces of the water in the channel, external forces including seepage from the bank and gravity can induce slope failures. Although a detailed discussion of soil properties and special geotechnical problems related to streambank stabilization projects is beyond the scope of this manual, a review of the factors that influence bank retreat can be found in Lagasse et al. (2012). A detailed discussion of soil properties and special geotechnical problems is also provided in NRCS's NEH Part 654, Technical Supplement 14A (NRCS, 2007).

3.5 DESIGN CRITERIA

Fundamentally, stream systems have flow regimes with characteristic components with respect to the magnitude, frequency, duration, timing, and rate of change of the hydrologic conditions that regulate ecological processes (Poff et al., 1997). Departure from natural flow regimes through anthropogenic disturbances often lead to impairments that precipitate stream restoration projects. In practice, the design discharges implemented in stream restoration projects most often include bankfull discharge and flood discharge, as discussed below. Environmental flow requirements, using low flow approaches or methods such as ELOHA (Ecological Limits of Hydrologic Alteration) for support of aquatic life and riparian function, may also be required, or at least informative, for some projects (Poff et al., 2010). This is especially important where the flow regime is fundamentally disturbed and flow diversions and excessive groundwater pumping periodically dewater channels. Sufficient flow through the riparian corridor is also required for maintaining the riparian vegetation located at the center of bioengineering treatments.

Bankfull and Effective Discharge

During periods of relatively stable climatic and stream boundary conditions (i.e., no significant change in channel vegetation or bank material), channels form to balance water and sediment inputs. Under these conditions “typical” high flow events shape what is termed the “bankfull” channel. Bankfull flow corresponds to a one to 2.5-year return interval flood (Leopold, 2006), which is frequent enough that mid- to late-seral vegetation typically does not persist within the bankfull zone. This *bankfull channel* is large enough to contain the stream under typical annual high flows and move the sediments delivered from upstream sources. The bankfull flow is the flood elevation that does the most geomorphic work over time, and as such is an important variable to consider when designing channel

and bank restoration treatments. When observing a stream's cross-section, roughly speaking a "bowl" shape can be seen that contains the annual peak flows most of the time. When flows exceed the bankfull capacity, the stream overflows its banks to inundate the floodplain (i.e., flooding). Refer to Klasz, Reckendorfer, and Gutknecht (2012) and Wolman and Miller (1960) for further reading on bankfull (i.e., effective) discharge.

When good indicators of channel-forming flow are present, bankfull discharge can be determined from discharge measurements collected when a given stream is flowing at or near bankfull. This method is most viable in snowmelt-dominated systems. Alternatively, bankfull discharge can be estimated at several stable cross sections by a normal depth assumption, though this method requires an accurate estimate of Manning's n for bankfull flow. The accurate identification of bankfull, however, may be difficult or impossible in highly disturbed reaches.

Bankfull discharge and geometric characteristics can also be estimated using regional regressions based on drainage area and, possibly, other watershed characteristics. This method can be problematic in mountainous areas where precipitation substantially varies. Wilkerson et al. (2014) suggest watershed area alone is insufficient to estimate regional bankfull width, and that precipitation variability should also be included. Additionally, stream diversions and reservoirs can also alter bankfull characteristics, further complicating or prohibiting the development of regional relationships.

Where discharge and sediment transport data are available (or can be reliably simulated), channel forming flow can be computed through use of the *Effective Discharge Methodology*. This methodology may be more reliable than assuming that bankfull discharge is equivalent to the channel-forming discharge (Soar & Thorne, 2001; Copeland et al., 2001; Soar & Thorne, 2011). However, some research indicates that effective discharge in some mountain streams is more related to maximum discharge rather than bankfull discharge (Bunte, Abt, Swingle, & Cenderelli, 2014), complicating standard approaches for implementation of effective discharge methodology in higher-gradient streams. There is some disagreement among scientists and practitioners whether or not bankfull discharge and effective discharge are equivalent. This manual uses the two terms interchangeably, realizing the precise definition of each term is the responsibility of the project designers.

Bankfull Channel Elevation

Bankfull channel elevation (i.e., bankfull stage) is typically defined at a point where the width to depth ratio is at a minimum, and is used in channel classification as well as for an initial determination of main channel dimensions, plan and profile. In many situations, the channel velocity begins to approach a maximum at bankfull stage. In cases such as on wide flat floodplains, discharge can drop significantly as the stream overtops its bank dissipates across the floodplain. In such a situation, it may be appropriate to use the bankfull hydraulic condition to assess stability and design streambank protection treatments. However, when the floodplain is narrower or obstructed, channel velocities

may continue to increase with rising stage. As a result, it may be appropriate to use a discharge greater than bankfull discharge to select and design streambank protection treatments.

Flood Discharge

Colorado is prone to large-magnitude floods, as is underscored by the devastating rain-induced events along the Front Range in 2013, 1997, and 1976. Numerous other historic floods have occurred in various parts of the State, including rainfall events that occurred in 1965 in the South Platte basin, 1935 in the Kiowa and Monument Creek watersheds, 1912 in the Cherry Creek watershed, and 1911 in the San Juan basin (National Center for Atmospheric Research, 2007). Additionally, snowmelt runoff has created large floods, such as in the Yampa River basin in 2011 and in the Colorado River basin in 1957 (U. S. Geological Survey [USGS], 1963). Considering the potential for future high flow events, combined with their associated sediment loads, floodplains should be managed with the conveyance capacity of both the stream channel and its floodplain in mind (i.e., the floodplain should be considered a natural extension of the river channel rather than a separate defensible space).

Flood Event Recurrence Interval

Flow frequency analyses are used to quantify the probability of various flood magnitudes expected on a particular stream reach. When discussing the range of possible events, the term *flood event recurrence interval* (aka “flood return interval”) is used. For example, the 2-year flood event, referred to as Q2 in this report, is the discharge event that has a 50% likelihood of occurring within a given year. Likewise, the 25-year and 100-year flood events have 4% and 1% likelihood of occurring with a given year, respectfully. If the project reach is in vicinity of a stream gauge of sufficient record length, flow frequency estimates can be obtained from the USGS or computed using the methods presented in Bulletin 17B (IACWD, 1982) and outlined in NRCS (2007). Yochum (2015) highlights tools available for performing flood-frequency analyses. For projects where stream gauge data is not available, regional flood frequency estimation treatments using multivariate regression approaches from gauged stream locations can be helpful. Based on such regional analyses, approximate flow frequency estimates can be obtained from USGS Streamstats (USGS, 2015). Because these values can be substantially over or underestimated, designers must pay particular attention to prediction errors when using this tool.

The amount of geomorphic change (i.e. bank instability) expected from a particular flood is often poorly associated with flood return intervals (Magilligan, 1992). This is due to the variability in stream power, with lower gradient streams with wide floodplains having a great deal less unit stream power for a specific return interval than a contributing mountain stream, despite lesser magnitude discharges. For example, a 50-year flood along the South Platte River near Fort Morgan, CO would spread across its broad and mild-sloped floodplain, exhibiting low unit stream power. In contrast, a 50-year flood in the contributing Big Thomson River upstream of Drake, CO (in a confined high-gradient valley), will have much higher unit stream power and much greater potential for streambank instability (e.g. and major geomorphic change).

Flow duration is a confounding problem, since long duration floods expend much greater total energy and, consequently, have a greater potential for geomorphic change. Streambank resisting forces, which are influenced by bank composition, flow resistance, vegetation type and extent, and riprap, illustrate additional complexities in predicting the degree of geomorphic change expected from a flood.

Considering the large amounts of geomorphic work done (e.g., by high unit stream power) in the canyon and narrow stream valleys during the 2013 Front Range Flood, it can be readily understood that the most effective discharge in some areas may be flood flows, as Bunte et al. (2014) argues. However, such a situation is not an excuse to design over-sized stream channels that can convey high flood flows. Rather, multiple flow magnitudes should be used in the design process. Bankfull flow channels should be incorporated into designs with flood flows used as a check for sufficient floodplain capacity without spikes in unit stream power and shear stress that can cause floodplain-wide destabilization or localized bank instabilities that threaten bioengineering and other types of bank stabilization projects.

3.6 EVALUATING BIOENGINEERING TOLERANCES

While streambank bioengineering offers diverse treatments capable of addressing a wide range of project goals, treatments must be tailored to each site and situation. Further, designers must ensure the materials and methods utilized on streambanks will be stable for the full range of conditions expected during the design life of the project.

The ability of soil bioengineering measures to protect a streambank depends, in part, on the force water exerts on the streambank during the design event. Erosion occurs when the hydraulic forces of the flow exceed the resistive forces of the streambank. The effects of the water current on the stability of the streambank (i.e., the soil, vegetation and bioengineering measures), therefore, must be considered and evaluated. As such, some degree of hydraulic calculation and/or modeling is typically required for all restoration projects, with the degree of complexity defined by the magnitude and objectives of the project, as well as acceptable risk. Two reference values provided by hydraulic calculations and modeling that can be used to evaluate relative resistance of bioengineering measures are:

- ◆ Maximum permissible velocity; and
- ◆ Critical shear stress.

These two parameters are briefly discussed herein, but it must be noted that many other factors can also influence the erosive effects of flow on streambanks. The emphasis of this section is to provide the designer with a frame of reference for the selection of bioengineering treatments and erosion control materials. Further detailed information regarding hydraulic effects on streambank stability is presented within the Reference Section of this manual.

Maximum permissible velocity

Permissible velocity is defined as the maximum flow velocity that will not cause erosion of the channel boundary. Permissible velocity is based upon a computed velocity for the channel geometry. While designers commonly make use of an average velocity at a given cross section, real streams contain eddies where flow circulates horizontally and areas of upwelling, roiling, and vertical circulation. Therefore, actual velocities in the plane of a cross section vary markedly from top to bottom, side to side, and in direction, varying with time and three-dimensional space (Fischenich, 2001).

Utilizing the reference of average velocity, the bioengineering treatment is assumed stable if the computed (average) channel velocity is lower than the maximum permissible velocity for the particular treatment. When utilizing velocity calculations as a reference, it must be noted the velocity on outside bends, also known as *impingement velocity*, may be assumed to be 33% greater than the average stream velocity (Fischenich, 2001). Selection of a velocity higher than average may be warranted for a given project based on goals and acceptable risk.

Critical Velocity

Lift and drag forces on a particle are directly related to the velocity squared. Thus, small changes in the velocity could result in large changes in these forces. The *permissible velocity* is defined as the maximum channel velocity that will not cause erosion of the channel boundary. It is often called the *critical velocity* because it refers to the condition necessary to initiate motion. Considerable empirical data exist relating maximum velocities to various soil and vegetation conditions.

However, this simple method for design does not consider the channel shape or flow depth. For example, channels of different shapes or depths may have significantly different forces acting on the boundaries given the same mean velocity. Critical velocity is depth-dependent and, therefore, a correction factor for depth must be applied to this method. Despite these limitations, maximum permissible velocity can be a useful tool in evaluating the stability of various streams and is most frequently applied as a cursory analysis when screening stabilization alternatives.

Shear Stress & Critical Shear Stress

Utilizing the reference of critical shear stress, the bioengineering treatment is assumed stable if the computed shear stress is less than the critical shear stress. Shear stress is a better measure of the fluid force on the channel boundary than is velocity, and conventional guidelines (including ASTM standards) rely upon shear stress as a means of assessing stability of erosion control materials (Fischenich, 2001). *Shear stress* is the force per unit area in the direction of flow. For uniform flow with small slopes, the flowing water exerts a time-average shear stress (τ_o), also known as *Reach Average Shear Stress*, in the direction of flow equal to the hydrostatic pressure times the channel slope:

$$\tau_o = \gamma DS_f$$

where γ is the specific weight of water (also called unit weight), D is the flow depth (approximate hydraulic radius), and S_f is the friction slope. Derived from consideration of the conservation of linear momentum, this quantity is a spatial average and may not provide a good estimate of bed shear at a point. For canyon and mountainous reaches of Colorado, a more appropriate shear stress equation would be:

$$\tau_o = \gamma R s$$

where R is the hydraulic radius (area/wetted perimeter) and s is slope. This assumes $\sin(\alpha)$ equals $\tan(\alpha)$, which equals slope, which is valid only for small angles. This equation's fundamental assumption is there is no acceleration of the fluid in the reach and therefore gravitational forces driving the water downstream are exactly offset by the resistance of the channel (bed and banks). This is conservation of linear momentum, also known as a balance between the forces.

Critical shear stress (τ_{cr}) can be defined by equating the applied forces to the resisting forces. Critical shear stress defines the force per unit area that will initiate movement of the grains on the channel bed. Shields (1936) determined the threshold condition by measuring sediment transport for values of shear at least twice the critical value and then extrapolating to the point of vanishing sediment transport. For soil grains of diameter d and angle of repose ϕ on a flat bed, the following relations can approximate the critical shear for various sizes of sediment:

$$\tau_{cr} = 0.5(\gamma_s - \gamma_w)d \tan\phi \text{ for clays}$$

$$\tau_{cr} = 0.25d_*^{-0.6}(\gamma_s - \gamma_w)d \tan\phi \quad \text{for silts and sands}$$

$$\tau_{cr} = 0.06(\gamma_s - \gamma_w)d \tan\phi \text{ for gravels and cobbles}$$

Where:

$$d_* = d \left[\frac{(G - 1)g}{\nu^2} \right]^{1/3}$$

γ_s = the unit weight of the sediment

γ_w = the unit weight of the water/sediment mixture

G = the specific gravity of the sediment

g = gravitational acceleration

ν^2 = the kinematic viscosity of the water/sediment mixture

The angle of repose ϕ for noncohesive sediments is provided in Table 3 (Julien, 1995), as are values for critical shear stress. The critical condition can be defined in terms of shear velocity rather than

shear stress (note that shear velocity and channel velocity are different). Table 3 also provides limiting shear velocity as a function of sediment size.

Fischenich (2001) notes that Table 3 provides limits that are best applied when evaluating idealized conditions, or the stability of sediments in the bed. Mixtures of sediments of different sizes tend to behave differently from homogenous sediments. Within a mixture, coarse sediments are generally entrained at lower shear stress values than presented in Table 3. Conversely, larger shear stresses than those presented in the table are required to entrain finer sediments within a mixture.

| Class Name | d_s (in) | ϕ (deg) | τ_c | τ_{cr} (lb/ft ²) | V_{*c} (ft/s) |
|----------------|------------|--------------|----------|-----------------------------------|-----------------|
| Boulder | | | | | |
| Very Large | >80 | 42 | 0.054 | 37.4 | 4.36 |
| Large | >40 | 42 | 0.054 | 18.7 | 3.08 |
| Medium | >20 | 42 | 0.054 | 9.3 | 2.20 |
| Small | >10 | 42 | 0.054 | 4.7 | 1.54 |
| Cobble | | | | | |
| Large | >5 | 42 | 0.054 | 2.3 | 1.08 |
| Small | >2.5 | 41 | 0.052 | 1.1 | 0.75 |
| Gravel | | | | | |
| Very coarse | >1.3 | 40 | 0.050 | 0.54 | 0.52 |
| Coarse | >0.6 | 38 | 0.047 | 0.25 | 0.36 |
| Medium | >0.3 | 36 | 0.044 | 0.12 | 0.24 |
| Fine | >0.16 | 35 | 0.042 | 0.06 | 0.17 |
| Very fine | >0.08 | 33 | 0.039 | 0.03 | 0.12 |
| Sands | | | | | |
| Very coarse | >0.04 | 32 | 0.029 | 0.01 | 0.070 |
| Coarse | >0.02 | 31 | 0.033 | 0.006 | 0.055 |
| Medium | >0.01 | 30 | 0.048 | 0.004 | 0.045 |
| Fine | >0.005 | 30 | 0.072 | 0.003 | 0.040 |
| Very Fine | >0.003 | 30 | 0.109 | 0.002 | 0.035 |
| Silts | | | | | |
| Coarse | >0.002 | 30 | 0.165 | 0.001 | 0.030 |
| Medium | >0.001 | 30 | 0.25 | 0.001 | 0.025 |

Table 3. Limiting Shear Stress and Velocity for Uniform Non-cohesive Sediments (Fischenich 2001)

Cohesive soils, vegetation, and other armor materials can be similarly evaluated to determine empirical shear stress thresholds. Cohesive soils are usually eroded by the detachment and entrainment of soil aggregates. Motivating forces are the same as those for non-cohesive banks; however, the resisting forces are primarily the result of cohesive bonds between particles. The bonding strength, and hence the soil erosion resistance, depends on the physio-chemical properties of the soil and the chemistry of the fluids. Field and laboratory experiments show that intact, undisturbed cohesive soils are much less susceptible to flow erosion than are non-cohesive soils.

Impact of Vegetation on Lift and Drag Forces

Vegetation has a profound effect on the stability of both cohesive and non-cohesive soils, thereby serving as an effective buffer between the water and the underlying soil. Vegetation cover increases the effective roughness height of the boundary, increasing flow resistance and displacing the velocity upwards away from the soil, which has the effect of reducing the forces of drag and lift acting on the soil surface. As the boundary shear stress is proportional to the square of the near-bank velocity, a reduction in this velocity produces a much greater reduction in the forces responsible for erosion.

Vegetation armors the soil surface, while their roots and rhizomes bind the soil and introduce extra cohesion over and above the intrinsic cohesion bank material possesses. The presence of vegetation does not render underlying soils immune from erosion, but the critical condition for erosion of a vegetated bank is usually the threshold of failure of the plant stands by snapping, stem scour, or uprooting, rather than for detachment and entrainment of the soils themselves. Vegetation failure usually occurs at much higher levels of flow intensity than for soil erosion.

Both rigid and flexible armor systems and materials can be used in streams to stabilize stream banks. Many manufactured products have been evaluated to determine their failure thresholds. Products are frequently selected using design graphs that present the flow depth on one axis and the slope of the channel on the other axis. Thus, the design is based on the depth/slope product (i.e., the shear stress). In other cases, the thresholds are expressed explicitly in terms of shear stress. Notable among the latter group are the field performance testing results of erosion control products conducted by the TXDOT/TTI Hydraulics and Erosion Control Laboratory (Texas Department of Transportation, 1999).

Table 4 presents limiting values for shear stress and velocity for a number of different channel lining materials. Included are soils, various types of vegetation, and a variety of commonly applied streambank bioengineering treatments. Information presented in the table was derived from a number of different sources by Fischenich (2001). Citations of these sources have been reprinted in Table 4 as they were originally included by Fischenich, but have not been included in this manual's list of references. The ranges of values presented in the table reflect various measures presented within the literature. In the case of manufactured products, the designer should consult the manufacturer's guidelines to determine thresholds for a specific product.

Fischenich (2001) notes the values presented in Table 4 generally relate to average values of shear stress or velocity. Velocity and shear stress are neither uniform nor steady in natural channels. Short-term pulses in the flow can give rise to instantaneous velocities or stresses of two to three times the average. Thus, erosion may occur at stresses much lower than predicted. Because the limits presented in Table 4 were developed empirically, they implicitly reflect some of this variability. However, natural channels typically exhibit much more variability than the flumes from which these data were developed.

Sediment load can also profoundly influence the ability of flow to erode underlying soils. Sediments in suspension have the effect of dampening turbulence, an important factor in entraining materials from the channel boundaries. As a result, velocity and shear stress thresholds in sediment-laden flows are 1.5 to 3 times those presented in the table.

In addition to variability of flow conditions, variation in the channel lining characteristics can influence erosion predictions. Natural bed material is neither spherical nor of uniform size. Larger particles may shield smaller ones from direct impact so that the latter fail to move until higher stresses are attained. For a given grain size, the true threshold criterion may vary by nearly an order of magnitude depending on the bed gradation. Variation in the installation of erosion control measures can reduce the threshold necessary to cause erosion.

| Boundary Category | Boundary Type | Permissible Shear Stress (lb/ft ²) | Permissible Velocity (ft/sec) | Citation(s) (see below) |
|---|------------------------------|--|-------------------------------|-------------------------|
| Soils | Fine Colloidal sand | 0.02 – 0.03 | 1.5 | A |
| | Sandy loam (noncolloidal) | 0.03 – 0.04 | 1.75 | A |
| | Alluvial silt (noncolloidal) | 0.045 – 0.05 | 2 | A |
| | Silty loam (noncolloidal) | 0.045 – 0.05 | 1.75 – 2.25 | A |
| | Firm loam | 0.075 | 2.5 | A |
| | Fine gravels | 0.075 | 2.5 | A |
| | Stiff clay | 0.26 | 3 – 4.5 | A, F |
| | Alluvial silt (colloidal) | 0.26 | 3.75 | A |
| | Graded loam to cobbles | 0.38 | 3.75 | A |
| | Graded silts to cobbles | 0.43 | 4 | A |
| | Shales and hardpan | 0.67 | 6 | A |
| Gravel / Cobble | 1-in. | 0.33 | 2.5 – 5 | A |
| | 2-in. | 0.67 | 3 – 6 | A |
| | 6-in. | 2.0 | 4 – 7.5 | A |
| | 12-in. | 4.0 | 5.5 – 12 | A |
| Vegetation | Class A turf | 3.7 | 6 – 8 | E, N |
| | Class B turf | 2.1 | 4 – 7 | E, N |
| | Class C turf | 1.0 | 3.5 | E, N |
| | Long native grasses | 1.2 – 1.7 | 4 – 6 | G, H, L, N |
| | Short native and bunch grass | 0.7 – 0.95 | 3 – 4 | G, H, L, N |
| | Reed plantings | 0.1 – 0.6 | N/A | E, N |
| Temporary Degradable Rolled Erosion Control Products (RECPs) | Hardwood tree plantings | 0.41 – 2.5 | N/A | E, N |
| | Jute net | 0.45 | 1 – 2.5 | E, H, N |
| | Straw with net | 1.5 – 1.65 | 1 – 3 | E, H, N |
| | Coconut fiber with net | 2.25 | 3 – 4 | E, M |
| Non-Degradable RECPs | Fiberglass roving | 2.0 | 2.5 – 7 | E, H, M |
| | Unvegetated | 3.0 | 5 – 7 | E, G, M |
| | Partially established | 4.0 – 6.0 | 7.5 – 15 | E, G, M |
| Riprap | Fully vegetated | 8.0 | 8 – 21 | E, G, M |
| | 6-in. D ₅₀ | 2.5 | 5 – 10 | F, L, M |
| | 9-in. D ₅₀ | 3.8 | 7 – 11 | H |
| | 12-in. D ₅₀ | 5.1 | 10 – 13 | H |
| | 18-in. D ₅₀ | 7.6 | 12 – 16 | H |
| 24-in. D ₅₀ | 10.1 | 14 – 18 | E | |

| | | | | |
|--|--------------------------------|------------|---------|---------------|
| Bioengineering | Wattles | 0.2 – 1.0 | 3 | C, I, J, N |
| | Reed fascine | 0.6 – 1.25 | 5 | E |
| | Coir roll | 3 – 5 | 8 | E, M, N |
| | Vegetated coir mat | 4 – 8 | 9.5 | E, M, N |
| | Live brush mattress (initial) | 0.4 – 4.1 | 4 | B, E, I |
| | Live brush mattress (grown) | 3.9 – 8.2 | 12 | B, C, E, I, N |
| | Brush layering (initial/grown) | 0.4 – 6.25 | 12 | E, I, N |
| | Live fascine | 1.25 – 3.1 | 6 – 8 | C, E, I, N |
| | Live willow stakes | 2.1 – 3.1 | 3 – 10 | E, N, O |
| Hard Surfacing | Gabions | 10 | 14 – 19 | D |
| | Concrete | 12.5 | >18 | H |
| ¹ Ranges of values generally reflect multiple sources of data or different testing conditions. A. Chang, H.H. (1988) F. Julien, P.Y. (1995) K. Sprague, C.J. (1999) B. Florineth (1982) G. Kouen, N., Li, R.M., and L. Temple, D.M. (1980) C. Gerstgraser, C. (1988) Simons, D.B. (1980) M. TXDOT (1999) D. Goff, K. (1999) H. Norman, J.N. (1975) N. Data from Fischenich (2001) E. Gray, D.H., and Sotir, R.B. I. Schiechtl, H.M. and Stern, R. O. USACE (1997) (1996) (1996) J. Schoklitsch, A. (1937) | | | | |

Table 4. Permissible Shear and Velocity for Selected Lining Materials (Fischenich, 2001)¹

Changes in the density or vigor of vegetation can either increase or decrease the erosion threshold. Even differences between the growing and dormant seasons can lead to one- to two-fold changes in the erosion threshold. To address such uncertainty and variability, the designer should adjust the predicted velocity or shear stress by applying a factor of safety or by computing local and instantaneous values for these parameters. Guidance for making these adjustments is provided by Fischenich (2001).

It should be noted that the local maximum shear can be up to 50% greater than the average shear in straight channels and even greater along the outer banks of sinuous channels. Temporal maximums may also be 10 to 20% greater, as well (Fischenich, 2001). Similar to maximum permissible velocity analysis, selection of a shear stress higher than average may be warranted for a given project based on goals and acceptable risk.

Correlation of Bioengineering Treatments to Permissible Shear Stress and Velocity

A variety of bioengineering treatments can be used to protect and stabilize streambanks from erosion. A variety of manufactured products have been evaluated to determine their failure threshold, providing valuable information to designers. The data included in this section represent a portion of the limited, existing body of information regarding failure thresholds for streambank bioengineering treatments (NRCS, 2007).

Table 5 is adapted from the *Streambank Soil Bioengineering Technical Supplement* of the *National Engineering Handbook* (NRCS, 2007). It presents limiting values for shear stress and velocity for a number of different bioengineering treatments. Although a limited number of treatments are presented, the designer can compare treatments with similar attributes to those listed in the table to

estimate the limiting shear stress or velocity. The recommendations must be scrutinized and modified according to site-specific conditions such as duration of flow, underlying soils, vegetation cover, plant species composition, aspect, temperature, debris and sediment load in the stream, as well as channel shape, slope and planform. Specific cautions are also noted in the table. There are anecdotal reports, however, that mature and established bioengineering measures can withstand larger forces than those indicated in the table (NRCS, 2007).

| Bioengineering Treatment | Permissible shear stress (lb./ft ²) | Permissible velocity (ft./s) |
|--|---|---|
| Live poles (Dependent on length of poles & nature of the soil) | Initial: 0.5 to 2 Established: 2 to 5+ | Initial: 1 to 2.5 Established: 3 to 10 |
| Live poles in woven coir TRM (Dependent on installation & anchoring of coir) | Initial: 2 to 2.5 Established: 3 to 5+ | Initial: 3 to 5 Established: 3 to 10 |
| Live poles in riprap (joint planting) (Dependent on riprap stability) | Initial: 3+ Established: 6 to 8+ | Initial: 5 to 10+ Established: 12+ |
| Live brush sills with rock (Dependent on riprap stability) | Initial: 3+ Established: 6+ | Initial: 5 to 10+ Established: 12+ |
| Brush mattress (Dependent on soil conditions & anchoring) | Initial: 0.4 to 4.2 Established: 2.8 to 8+ | Initial: 3 to 4 Established: 10+ |
| Live fascine (Very dependent on anchoring) | Initial: 1.2 to 3.1 Established: 1.4 to 3+ | Initial: 5 to 8 Established: 8 to 10+ |
| Brush layer / branch packing (Dependent on soil conditions) | Initial: 0.2 to 1 Established: 2.9 to 6+ | Initial: 2 to 4 Established: 10+ |
| Live crib wall [Dependent on nature of the fill (rock or earth), compaction & anchoring] | Initial: 2 to 4+ Established: 5 to 6+ | Initial: 3 to 6 Established: 10 to 12 |
| Vegetated reinforced soil slopes (VRSS) (Dependent on soil conditions & anchoring) | Initial: 3 to 5 Established: 7+ | Initial: 4 to 9 Established: 10+ |
| Grass turf - Bermuda grass, excellent stand (Dependent on vegetation type & condition) | Established: 3.2 | Established: 3 to 8 |
| Live brush wattle fence (Dependent on soil conditions & depth of stakes) | Initial: 0.2 to 2 Established: 1.0 to 5+ | Initial: 1 to 2.5 Established: 3 to 10 |
| Vertical bundles (Dependent on bank conditions, anchoring, & vegetation) | Initial: 1.2 to 3 Established: 1.4 to 3+ | Initial: 5 to 8 Established: 6 to 10+ |

Table 5 - Permissible Shear Stress and Velocity Levels for Streambank Bioengineering Treatments

Table 6 presents limiting values for shear stress and velocity for various streambank stabilization materials. Included are types of vegetation and a number of commonly applied stabilization measures. Ranges of values generally reflect multiple sources of data or different testing conditions. In the case of manufactured products, the designer should consult the manufacturer's guidelines to determine thresholds for a specific product. Ranges of values presented in the table reflect various measures presented within the literature (J. Fripp, personal communication, January 11, 2016).

| Bank Material / Protection | Shear Stress (lb/ft ²) | Velocity (ft/s) | Criteria Type | Source |
|---|------------------------------------|-----------------|---------------|--------------------------|
| Bermuda grass, erosion resistant soils, 0-5% slope | | 8 | Design | USDA, 1947 (rev. 1954) |
| Bermuda grass, erosion resistant soils, 5-10% slope | | 7 | Design | |
| Bermuda grass, erosion resistant soils, over 10% slope | | 6 | Design | |
| Bermuda grass, easily eroded soils, 0-5% slope | | 6 | Design | |
| Bermuda grass, easily eroded soils, 5-10% slope | | 5 | Design | |
| Bermuda grass, easily eroded soils, over 10% slope | | 4 | Design | |
| Grass mixture, erosion resistant soils, 0-5% slopes | | 5 | Design | |
| Grass mixture, erosion resistant soils, 5-10% slopes | | 4 | Design | |
| Grass mixture, easily eroded soils, 0-5% slopes | | 4 | Design | |
| Grass mixture, easily eroded soils, 5-10% slopes | | 3 | Design | |
| Grasses: <i>Lespedeza sericea</i> , weeping lovegrass, yellow bluestem, kudzu, alfalfa, crabgrass, common lespedeza; erosion resistant soil, 0% slope unless on side slopes | | 3.5 | Design | |
| Grasses: <i>Lespedeza sericea</i> , weeping lovegrass, yellow bluestem, kudzu, alfalfa, crabgrass, common lespedeza; easily erodible soil, 0% slope unless on side slopes | | 2.5 | Design | |
| Dense sod, fair condition growing in moderately cohesive soil | 0.35 | | Limit | Austin and Theisen, 1994 |
| 12.5 cm of excellent growth of grass/woody veg on outside bend | 1 | | Limit | Parsons, 1963 |
| Flume trials, fabric reinforced veg failed after 50 hrs | 5 | | Limit | Theisen, 1992 |
| Flume trials, fabric reinforced veg failed after 8 hrs | 8 | | Limit | |
| Sod revetment, short period of attack | 0.41 | | Design | Schoklitsch, 1937 |
| Wattles (coarse sand between) | 0.2 | | Design | |
| Wattles (gravel between) | 0.31 | | Design | |
| Wattles (parallel or oblique to current) | 1 | | Design | |
| Fascine revetment | 1.4 | | Design | |
| Cribs with stone | 30 | | Design | |
| Reed plantings (immediately after construction) | 0.10 | | Limit | Schiechl and Stern, 1994 |
| Reed plantings (after 3-4 seasons) | 0.61 | | Limit | |
| Reed roll (immediately after construction) | 0.61 | | Limit | |
| Reed roll (after 3-4 seasons) | 1.22 | | Limit | |
| Wattle fence (immediately after construction) | 0.20 | | Limit | |

| Bank Material / Protection | Shear Stress (lb/ft ²) | Velocity (ft/s) | Type of Criteria | Source |
|---|------------------------------------|-----------------|------------------|-----------------------------------|
| Wattle fence (after 3-4 seasons) | 1.02 | | Limit | |
| Live fascine (immediately after construction) | 1.22 | | Limit | |
| Live fascine (after 3-4 seasons) | 1.63 | | Limit | |
| Willow brush layer (immediately after construction) | 0.41 | | Limit | |
| Willow Brush layer (after 3-4 seasons) | 2.86 | | Limit | Schiechtl and Stern, 1994 (cont.) |
| Willow mat (immediately after construction) | 1.02 | | Limit | |
| Willow mat (after 3-4 seasons) | 6.12 | | Limit | |
| Deciduous tree plantings (immediately after construction) | 0.41 | | Limit | |
| Deciduous tree planting (after 3-4 seasons) | 2.45 | | Limit | |
| Live stakes in riprap (immediately after construction) | 2.04 | | Limit | |
| Live stakes in riprap (after 3-4 seasons) | 6.12 | | Limit | |
| Coarse gravel and stone cover with live cuttings (immediately after construction) | 1.02 | | Limit | |
| Coarse gravel and stone cover with live cuttings (after 3-4 seasons) | 5.10 | | Limit | |
| Coir fiber roll, single stake, <1:3 slope | 0.2 - .8 | 5 | Design | |
| Coir fiber roll, double stake, with brush mat | 0.8 - 3.0 | 8 | Design | |
| Turf reinforcement mat, permanent | 8 | 20 | Design | Rolanka Product Literature |
| Straw reinforcement mat, temporary | 0.45 | 8 | Design | |
| Jute mat | 0.45 | | Design | Chen and Cotton, 1988 |
| Straw with net | 1.45 | | Design | |
| Curled wood net | 1.55 | | Design | |
| Synthetic mat | 2 | | Design | |
| Rootwads | | 8.7 | Observation | Allen and Leech, 1997 |
| Rootwads | | 12 | Observation | |
| Willow posts | | 3.1 | Observation | |
| Herbaceous and woody | | 8 | Design | |
| Soil cement | | 25 | Limit | Portland Cement Association |
| Brush mattress w/willows | 6.5 | | Limit | Gerstgraser, 1999 |

| Bank Material / Protection | Shear Stress (lb/ft ²) | Velocity (ft/s) | Type of Criteria | Source |
|---|------------------------------------|-----------------|------------------|-----------------------|
| Wattle fence | 1 | | Limit | Gerstgraser, 1999 |
| Fascine | 2.1 | 9.8 | Limit | |
| Cuttings of willows/willow stakes | 2.1 | 9.8 | Limit | |
| Articulated concrete mats, unvegetated, COE block, 40% open | 4.3 | 13.2 | Limit | Lipscomb et al., 2001 |
| Articulated concrete mats, vegetated, COE block, 40% open | 6.1 | 13.8 | Limit | |

Table 6: Permissible Shear and Velocity Data Compiled in Late 1990s by Fripp

The values presented in Table 6 generally relate to average values of shear stress or velocity. However, as discussed previously, velocity and shear stress are neither uniform nor steady in natural channels. Short-term pulses in flow can give rise to instantaneous velocities or stresses two to three times greater than the average, resulting in erosion under much lower stresses than predicted (Fischenich, 2001). Alternatively, 3-dimensional variability in shear stress can also lead to erosion initiating at reach-average stresses substantially higher than predicted. The designer should consider project-specific factors to determine whether to compare average values to the table values or to increase conservatism.

3.7 CONCLUDING REMARKS

Streambank bioengineering offers a diverse realm of treatments for streambank stabilization and habitat naturalization. However, these treatments are not appropriate for all sites and situations. Due to the extensive benefits resulting from the use of streambank bioengineering treatments, the designer would do well by considering these treatments on equal footing with the many traditional tools available. In many cases, plant-based bioengineering treatments should be considered first, such that use of harder (structural-based) treatments occurs only after determining softer (plant-based) treatments are inadequate.

Hydraulic calculations, including velocity and shear stress, provide reasonable reference values upon which to base a decision regarding the use and type of bioengineering measures to consider. However, when these hydraulic forces exceed the maximum or critical threshold of plant-based bioengineering treatments being considered, other treatments and/or materials may be required in conjunction with the plant-based measures to ensure stability (i.e., incorporating both structural and plant-based treatments into the project). The designer must be creative and integrative such that the project yields the desired stability, aesthetics and ecosystem services desired.

4.0 PLANT-BASED BIOENGINEERING: DESIGN CONSIDERATIONS

While the introductory chapter placed emphasis on the need to consider rivers holistically, the purpose of this manual is to present fundamental concepts that, when applied well, increase the likelihood of success of bioengineering projects. The aim of this chapter is to provide fundamental knowledge of plant community ecology, revegetation treatments, and other basics necessary to successfully design and implement plant-based treatments. Because terminology used to describe such work varies across the country, and among practitioners on a single project, the next sections provide some basic terminology.

Plant-Based Bioengineering Approach

A purely plant-based streambank bioengineering approach does not intend to produce a static bank line (Fripp et al. 2008). Rather, a successful bioengineering produces a non-static bank line, with the ability to rebound in an unaided manner following perturbation. Plant-based treatments may be integrated with structural-based treatments, and accompany bank grading to meet short- to mid-term stabilization needs. Fundamentally, plant-based treatments rely on the strength of plant roots and stems to provide long-term protection of a bank. Unlike structural treatments, plant-based treatments are weakest in the months following construction, and may require 3 to 10 years to reach their full design goals. Plant-based treatments rely on materials such as willow cuttings, seed, container stock, and vegetative plugs. These and other plant materials are used to construct plant-based structures such as fascines and brush mattresses, and can also be integrated with physical structures to form a wide variety of effective treatments. While some plant-based treatments provide short-term bank stability, other treatments such as seeding require soil surface protection to minimize soil loss until seeded species become established. Such surface protection treatments will be covered briefly at the end of this chapter.

4.1 CHARACTERIZATION OF RIPARIAN SYSTEMS

Riparian zones are among the most biologically diverse and ecologically important zones throughout the semi-arid west. They comprise important migratory routes between mountain and plain habitats, support migratory birds in route to winter and summer residences as far away as Alaska and Argentina, create cover for resident wildlife, and serve as the foundation for an entire food web of adjacent aquatic and upland systems. Throughout Colorado, the upper canopies of cottonwoods (*Populus* spp.), aspen (*P. tremuloides*), blue spruce (*Picea pungens*), and other mature trees provide important nesting habitat for bald eagles (*Haliaeetus leucocephalus*) and other raptors. They also provide rookery habitat for great blue herons (*Ardea herodias*), and nesting habitats for owls and a variety of cavity nesting birds. Additionally, rare species such as the Preble's meadow jumping mouse

(*Zapus hudsonius*, spp. *preblei*), Colorado butterfly plant (*Gaura neomexicana*, spp. *coloradensis*), and Ute ladies'-tresses orchid (*Spiranthes diluvialis*) rely upon healthy riparian habitats for survival.

Healthy riparian areas have the ability to reduce sedimentation of waterways by filtering pollutants from adjacent upland areas and reducing the rate of soil loss from banks and upland areas. Riparian areas provide valuable benefits to streams such as shading (e.g., reduced stream temperatures) and organic matter inputs (i.e., leaves and large woody debris) that serve as a food source for many aquatic macroinvertebrates. Moreover, healthy riparian areas provide significant aesthetic value to residents and tourists who experience thousands of miles of riverine systems while driving transportation corridors throughout Colorado. Due to the contribution of riparian corridors to the conservation and management of freshwater fish (Pusey & Arthington, 2003) and big game, and given the millions of dollars of revenue generated by hunting and fishing in Colorado annually, the restoration and protection of riparian systems produces economic benefits for the State.

Given the myriad benefits of riparian plant communities, incorporating plant-based treatments into river, floodplain, and streambank stabilization projects becomes not simply a nice option if affordable, but rather an essential practice of policy makers, planners, and practitioners alike. While working to optimize a project budget, it is essential to remember plant-based treatments are often a fraction of the cost of an entire river restoration project.

Streambank Zoning

In their seminal 2005 paper, Hoag and Fripp present a modified interpretation of the classic streambank zones based on the conditions of a semi-arid climate. Rather than the traditional zones of toe, splash, bank, and terrace, Hoag and Fripp (2005) suggest the use of toe, bank, overbank, transitional, and upland as the riparian zones into which vegetation arrays and bioengineering treatments should be placed (Figure 4). The recommendations included in the electronic *Revegetation Matrix* (Mandel, 2016a) provided as a supplement to this manual include riparian planting zones and root architecture by species, assisting the designer with the development of site-fitted revegetation plans.

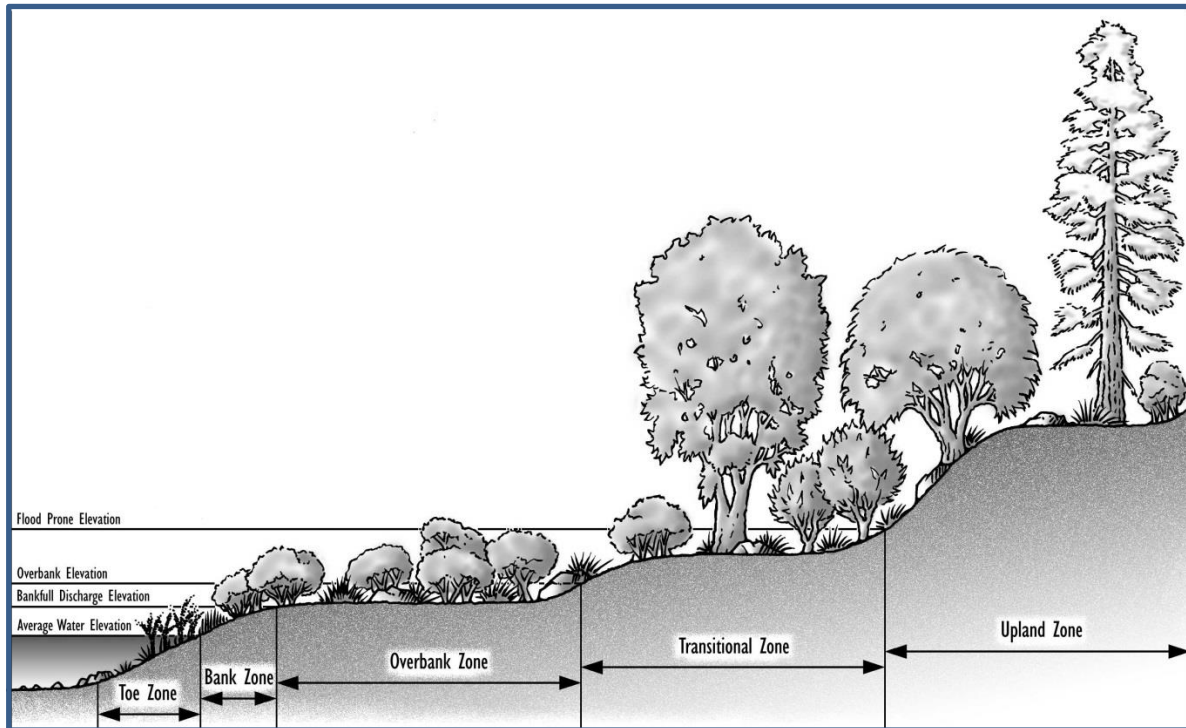

Figure 4: Riparian Planting Zones in Semi-Arid Climates (Reprinted with permission from Hoag and Fripp, 2005)

Toe Zone

The *toe zone* is located immediately below the average water elevation, and typically experiences the highest stress of all the following zones. The cross-sectional area at the average water elevation often defines the limiting biologic condition for aquatic organisms. Due to the long periods of water inundation experienced at the toe zone, this zone will rarely support woody vegetation. The stability of the toe zone is of vital importance to the stability of the entire adjacent bank.

Bank Zone

The *bank zone* is located between the elevation of the average base-flow water surface and the bankfull discharge elevation. The bank zone is exposed to the erosive forces of surface waves and flowing water, resulting in frequent stress. The dynamic nature of this zone often results in its colonization by early seral (i.e., pioneer) riparian vegetation, including willows and other low-growing hydrophytic (i.e., water loving) shrubs and herbaceous plants. The bank zone is not commonly dominated by mid-seral and late-seral vegetation that represent “late successional” communities. A presentation of vegetation seral communities and succession is provided in a subsequent section.

Overbank Zone

The *overbank zone* is located between the bankfull discharge elevation and the overbank elevation. Typically flat, this zone may be formed through sediment deposition, forming layered soils. The overbank zone is flooded with an average frequency of every 2 to 5 years. Vegetation found in this zone is typically flood tolerant and may have a high percentage of hydrophytic plants. Shrubby willow species, dogwoods, alder, birch and others often occur in this zone. More upright willow species, cottonwoods, and other trees may occur in the upper elevations of the overbank zone.

Transitional Zone

The *transitional zone* is located between the overbank and upland zones. This zone may be inundated every 35 to 75 years and is not exposed to high velocities except during high water events. A preponderance of hydrophytic vegetation generally transitions to a dominance of upland species in this zone. The plants in this zone need not be especially flood tolerant.

Upland Zone

The *upland zone* is that portion of the landscape located above the flood prone elevation. This zone is further from water, requiring the dominant vegetation to be more drought tolerant and of a more upland nature (i.e., mesic or xeric). Note that in highly disturbed conditions (i.e., fresh alluvium deposited throughout the site by recent flooding, recent bank scour, etc.), upland vegetation may occur in the transitional and overbank zones.

Plant Community Succession

A guiding concept of ecological restoration is *succession*, the change in species composition within a plant community over time. As ecological disturbance is a key component driving landscape level diversity, and succession is a reactionary process to disturbance, the resulting plant community is in a constant state of flux. This dynamic and successional nature of riparian communities, given the regularity of flood cycles that occur within river channels, is a reflection of the dynamic nature of riverine systems. As such, the goal of many plant-based treatments is to establish the system's fundamental biotic components that will hasten the recovery process and lead to a self-sustaining riparian plant community. The key is to understand that the long-term condition (i.e., 10 to 20 years) of the treated area will be substantially different than the short-term (i.e., 3 to 5 years) condition. Not only does the biological complexity of a restored site increase over time, but the resiliency of a site typically increases over time. To the degree that practitioners understand vegetation communities (similar to fluvial systems) are not static, but are rather in a constant state of adjustment following perturbation, the revegetation planning and design process will be commensurately improved.

In their paper “Mechanisms of succession in natural communities and their role in community stability and organization”, Connell and Slater (1977) provide a comprehensive summary of the various components and perspectives of plant community succession. In the late 19th century, Cowles (1899) characterized successional patterns in his classic study of sand dunes along the shores of Lake Michigan. Further refinement and debate over succession was provided by Clements (1936), who described succession as a directional process leading to a climax plant community. Recognizing that a fixed climax condition is not readily observable in nature, researchers (Gleason, 1926; Smith, 1977; Grime, 1979; and Spurr & Barnes, 1980) further developed the concept of succession, describing plant communities as being maintained through complex interactions between individual organisms and their surrounding abiotic and biotic environments. Most ecologists of our day refer to the mature forest depicted in Figure 5 as existing in a state of dynamic equilibrium, wherein the species composition and structure is in a state of constant flux rather than existing as a predictable climax community.

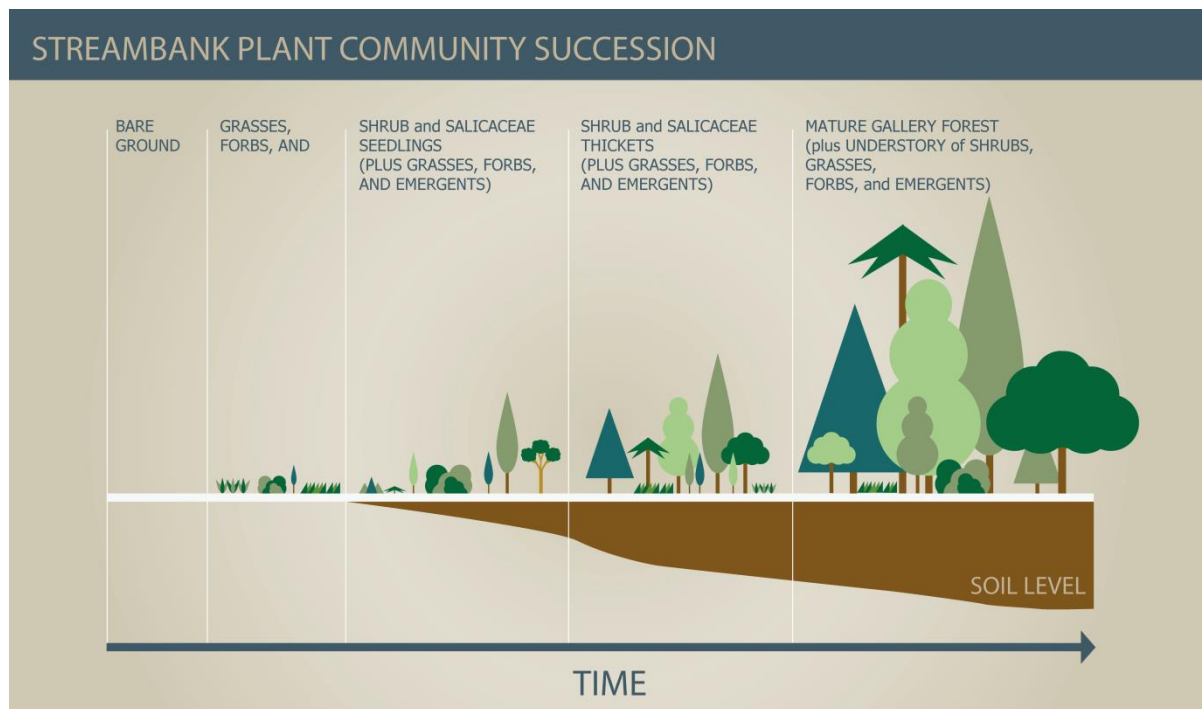

Figure 5: Plant community succession (Adapted with permission from Ellen MacArthur Foundation, 2016).

Plant community succession is typically divided into two primary classes depending on severity of disturbance: *primary* and *secondary succession*. In primary succession, nearly 100% of the biological elements adhered to the soil (soil biota, vegetation, and vegetative propagules such as seeds and rhizomes) are lost during geomorphic disturbances such as glacial advance, lava flow, or severe landslide. The 2013 Colorado floods created large geomorphic disturbances in floodplain and associated hillslope buffer zones that are undergoing primary successional processes. Two causal mechanisms resulted in this primary successional process: (1) significant scour that caused near

complete loss of the soil biota and associated vegetation; and (2) burial of flood-ravaged riparian zones by sand, cobble, debris, and other alluvium upwards of 12 feet deep (Figure 6).



Figure 6. Up to 12 feet of aggradation on the Big Thompson River. From Giordanengo, J. H. Reprinted with permission.

A significant portion of the floodplain following the 2013 flood is recovering also through secondary successional processes. Secondary succession results from disturbances wherein some portion of the biotic community remains intact following perturbation. Examples include recovery following avalanches, fire, intensive grazing, and moderate flooding. The duration of plant community recovery tends to be shorter following secondary succession than it is following primary succession due to the system retaining a sufficient proportion of its biotic community necessary to stimulate nutrient cycling, biological soil development, and rapid reestablishment of soil seedbanks.

The successional stage in which a particular plant species, or a suite of species, is most prevalent in a community can be described as its *seral stage*. Temporally, seral stages range from early- to mid- to late-seral (i.e. early- to mid- to late- successional). The concept of seral stage, and the knowledge of the species naturally present during each stage, is essential to the design and implementation of plant-based treatments. For instance, knowing the suite of early seral species that would naturally colonize a disturbed bank zone in Lyons, CO (5,350 feet a.s.l.) will facilitate development of an appropriate seed mix for bank stabilization along the St. Vrain River. The concept of functional groups, as they relate to seral stages, is a key consideration in the design of plant-based treatments.

Riparian Vegetation Functional Groups

The concept of plant functional groups is integral to understanding the role vegetation plays in bioengineering. A *functional group* is an assemblage of plants (or any taxonomic unit of life) according to morphological and/or physiological characteristics, responses to environmental conditions such as disturbance or nutrient status, or a combination of the above. This manual delineates the following functional groups according to implications for planning streambank bioengineering projects. It is important to note that none of these functional groups are static over time, and any individual species may be present in more than one functional group. For instance, narrowleaf and plains cottonwood (*Populus angustifolia* and *P. deltoides* ssp. *monilifera*, respectively) are aggressive colonizers of disturbed riparian zones under the correct moisture regime, and are also key components of mid- and late-seral plant communities.

Early Seral Herbaceous Vegetation

Early seral herbaceous vegetation plays a critical role in recovery following disturbance. A wide variety of grasses, rushes, sedges, and *forbs* (i.e., insect-pollinated and other herbaceous dicotyledon and monocotyledon species) are adapted to highly disturbed soils. This functional group is typically established via seed or small containers (i.e., 10 cubic inch or smaller) in areas where rapid vegetative recovery is necessary. One example is a recently graded bank, where rapid soil surface stability is an important objective. Mid- to late-seral species may be seeded together with early seral species, or natural *seed rain* (i.e., inputs via wind-blown or animal-dispersed seed) may be relied upon to stimulate the natural successional trajectory of the treated area. This functional group may also be important in low shear stress areas such as floodplains where rapid native vegetation is desirable due to: (1) threat of invasive species; (2) meet aesthetics expectations; (3) control wind-blown soil; (4) grazing requirements; or (5) wildlife habitat needs.

Mid- to Late-Seral Herbaceous Vegetation

Mid- to late-seral herbaceous species are more commonly found in plant communities 10 to 20 years post-disturbance. This functional group may be established from a combination of seed and container stock. Mid- to late-seral vegetation is included in a species mix where greater plant diversity is desired, or where late-seral vegetation will provide enhanced wildlife habitat, aesthetics, or domestic grazing value. The dense fibrous rootmat provided by a mid- to late-seral herbaceous community provides substantial bank protection against shear stress.

As basic ecological principles imply, and as recent research confirms, revegetation mixes containing a greater diversity of native species often produce more diverse plant communities, and are more resistant to invasion by weeds than when low diversity species mixes are used (Barr, Jonas, & Paschke, 2015; Herron, Jonas, Meiman, & Paschke, 2013). As result, plant mixes incorporating a variety of seral vegetation, and diversity of species within each sere, are likely to be more resilient over the long term, and are likely to better meet multiple objectives than low diversity plant mixes.

Early Seral Shrubs

Woody plants such as coyote willow, shining willow (*Salix lucida* spp. *caudata*), leadplant (*Amorpha fruticosa*), Wood's rose (*Rosa woodsii*), and others readily colonize bare ground and spread rapidly. Shrubs generally play a key role for wildlife by providing essential cover, food, and nesting habitat. Furthermore, the dense lateral woody roots associated with shrubs provide a degree of bank stability and protection that is difficult to attain by herbaceous vegetation alone. Due to the ability of willows to establish readily from vegetative cuttings, and to spread quickly, they are commonly used in a variety of bioengineering treatments within bank and overbank zones.

Mid- to Late-Seral Shrubs and Trees

The mid- to late-seral functional group is comprised of slower growing shrubs and trees that occupy the bank zone, overbank zone, and transitional zone. Examples include cottonwood, river birch (*Betula occidentalis* spp. *rivularis*), golden currant (*Ribes aureum*), thinleaf alder (*Alnus incana* spp. *tenuifolia*), Colorado blue spruce (*Picea pungens*), and others. Appropriate levels of diversity and density of shrubs and trees in this functional group provide essential floodplain roughness elements during overbank flood events, and creates important structural diversity (i.e., multiple canopy layers in a given point on the landscape) to riparian communities. Additionally, the height and horizontal spread of much of this vegetation provides significant organic inputs to the stream that support insect populations important to sustainable fisheries. Stream shading provided by mature shrubs and trees plays an important part in moderating stream temperatures, which benefits fish, amphibians, and other aquatic wildlife. Trout, for instance, require lower temperature waters, which hold greater levels of oxygen. Moderating stream temperatures can also reduce the incidence and severity of algal blooms.

4.2 PLANT-BASED DESIGN CONSIDERATIONS

As mentioned previously, herbaceous and woody plants increase soil tensile strength and structure, improve the rate of water infiltration into the soil, and support important wildlife habitat. Plant-based bioengineering treatments serve two basic functions: surface erosion protection and bank stabilization. The stabilization of streambanks to reduce the amount of total suspended solids entering the riparian zones is becoming a more common practice across North America. An important principle underlying streambank bioengineering is the use of woody and herbaceous root biomass to increase the strength and structure of the soil (Hoag & Landis, 2001). The remainder of this chapter focuses on how the practitioner can optimize plant-based treatments in the restoration of Colorado's diverse, often semi-arid, floodplain systems.

Influence of Bank Angle on Vegetation Establishment

Existing streambank angles result from factors including the location of the bank along the channel (i.e., inside or outside of a bend or in a straight reach), the lateral and vertical stability of the channel, the geotechnical properties of the bank material, and the characteristics of any vegetation that may

be present along the bank. Steeply sloped (greater than 60 degrees) banks are prone to active erosion and may contain little or no vegetation as result of ongoing channel and bank instability. Streambanks of lower angles suggest relative stability and, therefore, are better able to support vegetation.

As discussed previously, vegetation can effectively protect a bank by means of the root system and by means of the above-ground stems and foliage reducing shear stresses acting on the bank (e.g., by deforming and exerting drag on the plants rather than upon the soil particles). Thus, vegetation imparts resistance to erosion and helps maintain a stable bank slope. However, bank steepness has significant impacts on the ability for vegetation to become successfully established. In general, it is recommended that bank angles of 30 degrees or less be created when employing bioengineering treatments.

Persinger, Grmusich, Culler, and Jamison (2013) evaluated the use of back-sloping (re-grading) of the streambank to a 3:1 slope at five sites in Missouri. Graded slopes were revegetated with perennial ryegrass (*Lolium perenne*) and a variety of native shrubs and trees, and covered with erosion control fabric. Four of the sites failed because the vegetation did not establish quickly and the erosion control fabric was not sufficiently strong to protect the bank. Persinger and his colleagues reported the most significant factors limiting the long-term success of this technique are: (a) it is inappropriate for tight bends; and (b) it relies on the quick establishment of vegetation, particularly trees. They further indicate this approach appears to have merit as a supplement to other types of toe protection, but suggest it should not be used as a stand-alone technique. Measures that may mitigate this approach include toe protection, applying tips for successful vegetation establishment presented throughout this manual, and the variety of integrated plant- and structural-based treatments presented in subsequent chapters. The reader should refer to section 3 for further technical background on the influence of bank angles on the success of bioengineering treatments.

Water Supply

Access to water is fundamental to life on earth. In semi-arid environments such as Colorado, adequate water supply is critical to successful vegetation establishment. The key to improving the likelihood of success is to design plant-based treatments in a manner that ensures plant materials have access to water during the establishment phase, and during the driest times of the year following establishment. This is often accomplished by ensuring plant roots have adequate access to low season groundwater, as well as having access to the *capillary fringe* (i.e., zone of high soil moisture resulting from capillary rise above the water table) immediately above the groundwater. However, due to channel incision and modified hydrologic conditions following many floodplain disturbances, reliable access to water may not be possible.

Colorado's semi-arid conditions produce a larger degree of inter-annual variability in stream water tables than do streams in wetter regions of the country. As a result, it is important to design

revegetation treatments according to the low-season water table that is expected during the driest years on record. Ideally, this elevation is based on high temporal resolution ground water elevation measurements that span many years (i.e., on-site water monitoring and water-balance determination). In practice, this elevation is frequently determined using professional judgment through analysis of site conditions. It is therefore prudent to be conservative in the estimates of low-season water table.

When budgets allow, supplemental irrigation may be necessary to make a project more successful in the long-term by ensuring ample moisture during the establishment phase. While irrigation systems add to the overall cost and complexity of a given project, there are numerous cost-effective irrigation treatments that can be utilized, such as those mentioned in later in this chapter. Through irrigation, not only can revegetation outcomes become more predictable, but plant establishment margins can be widened beyond the *greenline* (i.e., the wettest vegetation zone immediately adjacent to the bankfull elevation of the stream). This widening can provide a broader spectrum of habitat types and species niches, each of which will impart improved resiliency to a given system. Additionally, broadening the overall revegetation zone through the use of drought-tolerant species provides more sustained levels of soil surface protection. As result, drought-tolerant vegetation maintains sufficient root biomass even during periods of drought. Consequently, shear stress and soil cohesiveness can be better mitigated despite reoccurring flood and drought cycles.

Root Parameters and Bank Strength

The effectiveness of riparian restoration designs at reducing bank erosion is influenced by the root-bulb dimension and rooting characteristics of the selected vegetation. As such, it is essential to understand the dominant rooting attributes of woody and graminoid species that impart strength to a bank. Rooting attributes must take into account root bulb dimension (depth and spread), root type (woody vs. fibrous, lateral versus tap, rhizomatous versus caespitose), root density, and soil type to determine the specific root strength provided by the specified plant materials. Below are descriptions of the Erodibility Index Method and root bulb strength, both of which bring a clearer understanding of the influence of roots on the erosion resistance of streambanks. The rooting attributes of each species are provided within the searchable electronic *Revegetation Matrix* provided as a companion resource to this manual (Mandel, 2016a).

Annandale Erodibility Index Method

As described previously, vegetated soils are more resistant to erosion than non-vegetated soils. As applied by Dr. George Annandale in 1995, the Erodibility Index Method incorporates the analysis of root architecture and root habit into the determination of resistance to soil erosion. The Erosion Index Method uses two root factors to determine *root bulb dimension* – root architecture and root habit. *Root architecture* refers to the geometric characteristics for a given root system (i.e., taproot versus fibrous root system), while *root habit* refers to how roots grow under a specific set of environmental conditions (Annandale, 2006).

Erodibility Index

The Erodibility Index is defined as:

$$K = M_s * K_b * K_d * J_a$$

Where: M_s - mass strength; K_b - block size; K_d - discontinuity bond shear strength; and J_a - relative ground structure.

In consideration of the relative ability of rooted vegetation to protect soil against erosion, the Erodibility Index characterizes mass strength, block size, inter-particle fraction, and the shape and orientation of the earth material (Annandale, 2006). The reader is referred to Annandale (2006) for definitions and additional information.

Of the factors comprising the Erodibility Index, mass strength and block size have the greatest influence upon resistance to erosion (Annandale, 2006). The determination of block size differs between rock and granular soil. In relation to rock, block size is a function of the rock joint spacing and the number of joint sets. Conversely, for granular soil, block size is function of particle size. The beneficial contribution of roots to the Erodibility Index is due to the nature of roots growing within soil matrices (clumps) of varying sizes, imparting greater resistance to water erosion than if those soil matrices did not contain roots. Roots, especially fibrous systems, have the ability to bind soil particles together to effectively form larger particle sizes. Accordingly, modifying the rooting features that impart greater cohesion to the soil (i.e., the soil profile) will provide the greatest resistance to erosional loss. When roots develop within the soil profile, their ability to increase mass strength is relatively insignificant, versus their potential to increase effective particle size, which is greatly significant. As such, the ability of fibrous roots to grow in tightly-bound clumps, in comparison to loosely bound clumps formed by tap-rooted systems, will have the greatest ability to bind particles and hence increase the relative particle size.

In application of the Erodibility Index Method (Annandale, 2006), there are no significant differences between non-vegetated and revegetated soil for the following factors: mass strength (M_s), interparticle shear strength (K_d), and the shape and orientation factor (J_s). Block size (K_b), however, does vary significantly between non-vegetated and revegetated sites. If the root architecture is known, it is possible to estimate the size of the “pseudo-particle” (i.e., block size) through the equation:

$$K_b = 1000D^3$$

In the above equation, D is the diameter of the root bulb bounded by the fibrous roots, as measured in meters. Once the index values of the other factors contributing to K have been assigned, it is possible to determine the Erodibility Index for a given revegetated area.

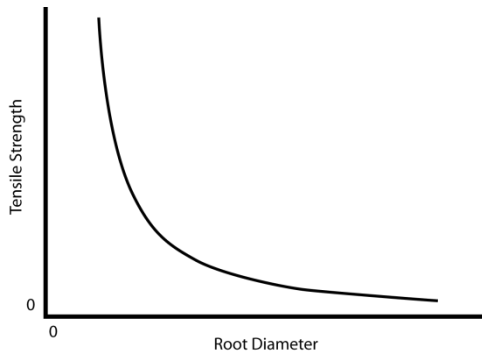

Figure 7: General trend between root diameter and tensile strength (Adapted from Simon and Collison, 2002)

Influence of Rooting on Bank Stability

There are numerous benefits provided through revegetated streambanks. In addition to increased habitat diversity and ecosystem functionality, undisturbed channels tend to have reduced sediment loads in comparison to disturbed channels (Simon, Pollen, and Langendoen, 2006; Langendoen & Simon, 2008; Pollen-Bankhead & Simon, 2009; Simon, Pollen-Bankhead, & Thomas, 2011). Multiple authors have analyzed the hydrologic and mechanical effects of streambank

revegetation, including reduced streambank erosion through particle entrainment and reduction of mass wasting (Simon et al., 2006; Langendoen, Lowrance, & Simon, Simon et al., 2011). The main contribution of plants to streambank resilience is through increased strength for bank sediments through reinforcement of the soil matrix (Figure 7) and through the reduction of soil pore water pressure (Abernathy & Rutherford, 2001; Simon & Collison, 2002 ; Pollen-Bankhead & Simon, 2009).

Streambank failure occurs when the gravitational forces that move sediment downslope exceed those forces that resist movement (Simon et al., 2006). The resulting potential for failure is expressed as a factor of safety (F_s) (Simon & Collison, 2002; Simon et al., 2006; Pollen-Bankhead, 2009). Bank geometry, fluvial toe undercutting, soil shear strength (as determined by effective cohesion and angle of internal friction), pore water pressure, confining pressure, and the mechanical and hydrologic effects of riparian vegetation together determine the critical parameters for bank stability (Simon et al., 2006; Cancienne, Fox, & Simon, 2008). Once failure occurs, eroded sediment may be (1) contributed to flow and deposited as bed material; (2) dispersed as wash load; (3) or deposited along the toe of the bank as either larger blocks or as smaller aggregates (Simon, Wolfe, & Molinas, 1991, March; Pollen-Bankhead & Simon, 2009).

Bank stability is influenced by the mechanical and hydrologic effects of riparian vegetation (Simon et al., 2006; Pollen-Bankhead & Simon, 2009). The mechanical influences of riparian vegetation are in large part beneficial (Simon et al., 2006). Roots are able to provide support and reinforcement to the soil matrix (Simon et al., 2006). To a large degree, reinforcement of the soil matrix is a function of root strength through their crossing of potential shear plains, as well as through the number and diameter of the contributing roots (Pollen-Bankhead & Simon, 2009). For the most part, soil tends to be strong in compression but weak in tension. Conversely, roots are strong in tension, but weak in compression (Simon et al., 2006; Pollen-Bankhead & Simon, 2009). As such, the combination of roots and soil are able to create a matrix that is stronger than either roots or soil in isolation (Simon et al., 2006). Roots reinforce the soil matrix through transference of shear stress within the soil to the tensile strength inherent within their structure (Thorne, 1990; Simon et al., 2006). The negative impact of vegetation on the soil – root matrix is largely a result of the weight of the vegetation itself, especially large trees, which increase the downward force (known as surcharge) on a given slope or streambank (Simon &

Collison, 2002; Simon et al., 2006). The common result of surcharge is to decrease soil stability to varying degrees (Simon & Collison, 2002; Simon et al., 2006).

Hydrologically, riparian vegetation is able to benefit streambank stability through the evapotranspiration of above-ground biomass (Simon & Collison, 2002; Simon et al., 2006). Through such phreatic removal, soil water pressure is reduced, thereby reducing the likelihood of mass failure (Simon & Collison, 2002; Simon et al., 2006). To the opposite effect, riparian vegetation has the negative impact of: (1) concentrating ambient rainfall around plant stems, hence creating increased soil pore pressure; and (2) disturbing soil coherency, thereby increasing infiltration, once again increasing pore pressure (Simon et al., 2006). The net effect of increased pore pressure is reduced bank stability (Simon & Collison, 2002; Simon et al., 2006).

As consequence of the inherent spatial and temporal variation of the composite root matrix and the properties of a given streambank, it is challenging to quantify the net effect of riparian vegetation upon channel stability (Simon et al., 2006). The magnitude of stability bestowed by the root matrix is dependent upon: (1) root growth and density (i.e. root architecture); (2) the tensile strength of the specific roots; (3) the root tensile strength modulus values; (4) the strength of the root-soil bond; and (5) the orientation of the roots relative to the principal direction of strain (Greenway, 1987; Simon et al., 2006). It has been shown that the factor of safety (Fs) shows the most variance when the ratio between the failure plane and the depth of rooting is the greatest (Pollen-Bankhead & Simon, 2009).

Several models have been created to estimate the contribution provided by the root matrix. The simple perpendicular root model was proposed by Waldron (1977), then modified by Wu, McKinnell, & Swanston (1979) (as described in Simon et al. 2006). The simple perpendicular model is based on the Coulomb equation:

$$S_r = c + (\sigma - \mu) \tan \varphi'$$

Where: S_r = shear strength (kPa), c = effective cohesion (kPa), σ = normal stress (kPa), μ = pore pressure (kPa), and φ' = angle of internal friction in degrees (Waldron, 1977; Wu et al., 1979; Simon et al., 2006; Pollen-Bankhead & Simon, 2009).

The simple perpendicular model assumes that roots extend only vertically across the zone of horizontal shear, within which roots act as laterally loaded piles (Simon et al., 2006; Pollen-Bankhead & Simon, 2009). This model assumes that the provided shear strength of the roots (ΔS) is simply added to the soil strength (Simon et al., 2006; Pollen-Bankhead & Simon, 2009). As such, the shear strength of the roots (ΔS) is calculated through use of the root tensile strength and the cross section of the roots relative to the area of the shear surface (Wu et al., 1979, as presented in Simon et al. 2006). Accordingly:

$$\Delta S = T_r (A_R/A) \quad 1.2$$

Where: T_r = root tensile strength (kPa), A_R/A = root area ratio (dimensionless), A = soil area (m^2), A_R = root area (m^2), and 1.2 = value that accounts for the angle of shear distortion and soil friction in degrees (Wu et al., 1979; Simon et al., 2006).

The greatest challenge with the simple perpendicular model is that it assumes that the entirety of the effective root mass attains ultimate soil strength, or conversely, mass failure, simultaneously during soil shear (Pollen et al., 2004; Pollen-Bankhead & Simon, 2009). However, as Pollen and her colleagues point out, roots break progressively (Pollen, Simon, & Collison, 2004; Pollen & Simon, 2005; Pollen-Bankhead & Simon, 2009) rather than instantaneously. To address this challenge, Pollen and her colleagues created the *RipRoot model* based upon fiber bundle theory to account for progressive root failure during shearing events (Pollen et al., 2004; Pollen & Simon, 2005; Pollen-Bankhead & Simon, 2009). In comparison to the simple perpendicular model, RipRoot takes into account roots within a given soil matrix have different maximum strengths and, therefore, break sequentially rather than simultaneously (Pollen et al., 2004; Pollen & Simon, 2005; Pollen-Bankhead & Simon, 2009). RipRoot produces more conservative resistive values than does the simple perpendicular model, thereby reducing the likelihood of over-estimation for streambank stability during shear events (Pollen et al., 2004; Pollen & Simon, 2005; Pollen-Bankhead & Simon, 2009). Pollen-Bankhead and Simon have shown that coupling of RipRoot with the Bank Stability and Toe Erosion Model (BSTEM) is able to predict stability and potential for lateral migration of restored stream and river channels (Pollen-Bankhead & Simon, 2009; Simon et al., 2011).

Cancienne and her colleagues determined that BSTEM tended to be from three to four times more sensitive to water table position than to root cohesion or seepage undercutting depth (Cancienne et al., 2008). Seepage undercutting has the greatest influence on streambank failure on unsaturated to partially saturated banks with root reinforcement, acting at distances as small as 20 cm (Cancienne et al., 2008). The influence of seepage undercutting decreased proportionally with an increase in water pore pressure and root reinforcement (Cancienne et al., 2008). Through the use of BSTEM, Simon and his colleagues demonstrated that the addition of toe protection to eroding streambanks can reduce the overall volume of eroded sediment from 85% to 100% (Simon et al., 2011). The incorporation of revegetation, however, must incorporate sufficient time to allow for development of a functional root matrix (3 to 5 years minimum, 7 to 10 years optimal) (Pollen-Bankhead & Simon, 2009; Simon et al., 2011).

Simon et al. (2006) compared the streambank stability of ponderosa pine (*Pinus ponderosa*) and Lemmon's willow (*Salix lemmonii*) on the Upper Truckee River in California. Simon and his colleagues determined that the smaller, more dense root matrix of Lemmon's willow provided a greater degree of streambank stability, and hence resilience, than did either the non-vegetated control site or ponderosa pine, which is a taprooted species (Simon et al., 2006). Additionally, Simon and his colleagues determined that Lemmon's willow had reduced soil water infiltration following precipitation, and hence reduced pore pressure and greater matric suction values, than did ponderosa pine (Simon et al., 2006). As result, Lemmon's willow imparted greater bank stability,

through reduction of negative hydrologic effects, in comparison to either the denuded control site or ponderosa pine site (Simon et al., 2006). The net result of the Truckee River study was the determination that Lemmon's willow could withstand steeper slope angles by up to 10 to 15 degrees, in comparison to ponderosa pine (Simon et al., 2006).

Various authors have investigated the spatial variability of the root matrix within natural environments. Abernathy and Rutherford demonstrated a decline in strength contribution from roots with increased lateral and vertical distance from the trunks of woody vegetation (Abernathy & Rutherford, 2000). Additionally, species type and age influences the relative contribution of roots (Simon et al., 2006; Pollen-Bankhead, 2009). Finally, it has been shown that root number decreases strongly with soil depth, with the predominance (over 50%) of roots occurring within the upper 3 m of soil (Jackson et al., 1996; Shenk & Jackson, 2002; Pollen-Bankhead & Simon, 2009). Accordingly, the amount of reinforcement that is contributed by roots to the soil matrix is reduced in a non-linear fashion with increased profile depth (Pollen-Bankhead & Simon, 2009). Jackson and his colleagues described this relationship as:

$$Y = 1 - \beta_d$$

Where Y equals the cumulative root fraction (between zero and unity) from the soil surface to a specific depth d (cm) and β is a fitted coefficient (Jackson et al., 1996; Pollen-Bankhead & Simon, 2009). In the Jackson model, higher β values indicate a greater proportion of roots at greater soil depths, and lower β values indicate a greater percentage of roots adjacent to the soil surface (Jackson et al., 1996; Pollen-Bankhead & Simon, 2009).

The contribution of root cohesion to the soil matrix has been estimated by the simple perpendicular model for various species to range from 2 to 30 kPa for various grasses and juvenile woody species to 125 kPa for mature trees (greater than 30 years) (Pollen & Simon, 2005; Simon et al., 2006; Pollen-Bankhead & Simon, 2009). Application of RipRoot modeling to these numbers reduced their value by approximately 40 to 60%, through adjustment for the erroneous assumption that the root matrix fails simultaneously, rather than sequentially, during shear events (Pollen-Bankhead & Simon, 2009). Adjusting the values via RipRoot altered the estimated root contribution to the soil matrix of various grasses and juvenile woody plants to 0.8 kPa to 18 kPa and for mature trees to 50 to 75 kPa (Pollen-Bankhead & Simon, 2009). Average values for example Rocky Mountain riparian species have been determined by Cancienne et al. (2008) to be:

- ◆ sandbar willow (*Salix exigua*) 4 years in age = 3.0 kPa and surcharge of 0.6 kN m⁻³
- ◆ plains cottonwood (*Populus deltoides*) 4 years in age = 8.0 kPa and surcharge of 0.6 kN m⁻³
- ◆ river birch (*Betula sp.*) 7 years in age = 8.0 kPa and surcharge of 0.6 kN m⁻³

- ◆ switchgrass (*Panicum virgatum*) 5 years in age = 18.0 kPa and surcharge of 0.0 kN m-3
- ◆ Fremont cottonwood (*Populus fremontii*) 14 years in age = 30.0 kPa and surcharge of 1.2 kN m-3

Regression analysis in relation to the number of roots crossing a potential shear plane over time showed only minor variation between species during the juvenile phase of plant development, but large variation in root number with plant maturity (Pollen-Bankhead & Simon, 2009). According to Pollen-Bankhead and Simon (2009), there was a rapid increase in root reinforcement between 3 to 5 years after establishment, and still greater contribution after 7 to 10 years of plant growth. The timing of contribution from rooted vegetation to soil stability may be affected by various factors including bank geometry, species type, and rooting depth relative to bank height, as well as soil type, soil moisture, aspect, underlying geology, and other variables (Abernathy & Rutherford, 1998; Pezeshki, 2001; Pollen-Bankhead & Simon, 2009). Pollen-Bankhead and Simon found that the factor of safety (F_s) for streambanks showed the most variance when the ratio between the failure plane length and the depth of rooting was greatest, as could occur when bank height was low, the failure block was shallow, and/or the failure surface angle was at a minimum (Pollen-Bankhead & Simon, 2009).

Timing of Plant Establishment

As discussed previously, one of the most vulnerable periods for plant-based bioengineering treatments is immediately after installation. Complicating this issue, the life cycle of plants is tied to seasonal fluctuations (i.e., precipitation, high water table, dormancy, frost-free periods, etc.) beyond the control of the practitioner. As such, timing installation of plant-based treatments according to known seasonal fluctuations will increase the likelihood of success. The vulnerable period can be addressed in a number of ways:

- ◆ Timing plant installation in such a manner as to establish substantial vegetation cover prior to high magnitude discharge events;
- ◆ Using fall or late winter seeding in order to take advantage of predictable levels of spring moisture (where appropriate). Depending on the species sown, fall seeding can result in more successful spring germination due to *vernalization* (cold-moist stratification) necessary to break dormancy of many seeds.
- ◆ Pre-soaking willow, cottonwood, and other hardwood cuttings before installation. Pre-soaked cuttings (7-14 days of soaking, depending on water temperature and species) result in greater root development by the time the stressors of summer arrive than un-soaked cuttings.

- ◆ In systems where peak flow occurs prior to bud-break, installing hardwood cuttings just after peak flow, when water tables are at a high level; and
- ◆ Incorporating a combination of seed, containerized materials, dormant woody materials, and vegetative divisions to facilitate rapid and diverse vegetation cover. Often times, these revegetation methods need to be installed at different times to enhance likelihood of success. As such, revegetation efforts should be a phased approach, each type of plant material being installed at the optimal time.

In Colorado, seasonal influences favor a growth period and dormant period in most riparian vegetation. During the dormant period (i.e., before bud-break), installed plants are more tolerant of the stresses accompanying the revegetation phase. As such, the likelihood of a plant surviving the initial vulnerable period is typically (i.e., wetland vegetation being an exception) increased when the construction occurs during the dormant phase of the plant's life cycle. Dormancy for most Colorado ecosystems extends from mid-November through early-March, depending on elevation. Importantly, these dormant periods typically occur when stream elevations are below the bankfull elevation, and hence accessible for equipment and crews. However, if the project designers are confident that revegetation zones will contain high moisture for substantial periods during and following peak flow (i.e., 1-2 months), installing container stock during or immediately following peak flow is warranted.

The typical hydrologic variability of the Colorado's streams is driven by snowmelt and precipitation. The seasonal increase in water caused by melting snow is directly linked to increasing temperatures, resulting in a peak discharge in early summer. In summer, storm-driven precipitation results in shorter duration and higher magnitude discharge events. Above 2300 m (approx. 7,546 ft.) elevation, snowmelt dominates the hydrographs, while below this elevation summer storms control the highest magnitude discharge events (Wohl, 2008). Southern Front Range counties have a higher incidence of monsoonal flows (i.e., steady and predictable July to August precipitation events) than northern Front Range counties. As shear stress generated by these high magnitude discharge events pose a threat to bioengineered treatments, timing of all construction activities should be planned around known seasonality of peak discharge.

Plant Community Trajectory Planning

An understanding of the plant community trajectory of a site should inform project design. Simply put, *plant community trajectory* is the progression (i.e., change in species composition, diversity, structure, etc.) of a plant community from the time of installation to the time of stand maturation. Historically, the late-seral community was known as the climax community, although in Colorado and most other ecosystems, the late-seral community is often controlled by site perturbation such as flooding. Knowledge of this progression should be incorporated into a planting mix by combining rapidly establishing early-seral species (i.e., Canada wildrye, *Elymus canadensis*) with, mid-seral (i.e., western wheatgrass, *Pascopyrum smithii*) and late-seral species (i.e., blue grama, *Bouteloua gracilis*)

to facilitate successful initial revegetation while still providing the plant materials that facilitate a more-complex and ecologically cohesive plant community over time.

Similarly, early-seral woody species such as sandbar willow should be planted in combination with slower-establishing willows such as Bebb's willow (*Salix bebbiana*) as well as alders and western river birch. This is best accomplished by including multiple species and plant material types (i.e., containers, cuttings, and seed) during project implementation. Additionally, appropriate proportions of early-, mid-, and late-seral species must be incorporated into the planting mix according to the habitat type that typifies a given site (i.e., *reference site*). This information is readily available through the services of a restoration ecologist and the use of the Revegetation Matrix accompanying this manual. Additional resources are available through databases such as the USDA NRCS Ecological Site Description Database (NRCS, 2015).

Management of Soil Surface Erosion

Soil erosion on streambanks is a result of natural geomorphic and fluvial processes, and is an important aspect of sediment balance within a river system. Natural levels of soil surface erosion can be caused by wind, precipitation, gravity, and animals. As such, the authors have refrained from any reference to “preventing soil erosion”. Recognizing that human impacts have resulted in significant constriction to river channels and vegetation alterations in many Colorado floodplains, the potential for exacerbated soil erosion and bank migration is higher than would be expected in undisturbed conditions. As such, mitigating the erosive forces impacting streambanks is recommended in an effort to reduce sedimentation of water sources that downstream communities and aquatic wildlife are dependent upon.

Soil erosion can be minimized through proper application of plant-based and structural-based treatments, or a combination of both classes of treatments. With regard to plant-based treatments, both above-ground and below-ground plant biomass is responsible for minimizing soil erosion. As outlined in preceding chapters, the above-ground (i.e., canopy) portion of a plant serves to reduce shear stress on otherwise barren soil, thus reducing the erosive forces acting upon the soil. Vegetation imparts additional erosion resistance to a bank via the soil-binding properties of roots. However, the soil protection provided by plants whose seasonal changes or life history traits result in a decrease in above- or below-ground biomass during high discharge events will leave soils vulnerable to erosion. One such example is the invasive winter annual known as cheatgrass (*Bromus tectorum*). The shallow roots of cheatgrass impart little tensile strength or reduction in near-surface shear stress once the plant goes dormant, typically during high-flow periods. To the contrary, the tensile strength provided by perennial herbaceous and woody vegetation, through the complexity and density of living roots, serves to protect the soil from erosion regardless of periods of dormancy or drought. Structural-based treatments, including erosion matting, intended to mitigate short- and long-term soil erosion are covered in Chapter 5.

Irrigation

While detailed irrigation solutions are beyond the scope of this manual, a few tips are provided as a means to highlight the options a practitioner has to improve the likelihood of revegetation success under periods of post-construction risk. Reliance upon irrigation (especially long-term irrigation) cannot compensate for proper species selection, plant materials selection, timing of installation, or quality of installation. Depending on budgets and logistics enhanced soil water measures can be provided in the short term (i.e., one to three years following construction) through treatments such as DRIWATER® (polymer – water matrices), a variety of short-duration surface irrigation systems (i.e., gravity-fed or municipal water-supported systems), or the use of water trucks and existing water sources.

Besides the restrictions provided by the actual water supply, cost-effective irrigation is often limited by access to power needed to run electrical pumps. There are, however, options to overcome this obstacle. Depending on the depth to groundwater, and other variables, solar energy panels may provide adequate power to run pumps. Gravity-fed systems utilizing 300-1,000 gallon tanks and a system of drip irrigation lines can also be cost effective. Shallow groundwater wells that access the local surficial aquifer are often used as a water source. It is necessary to ensure that such water supply wells comply with local regulations and permitting requirements. Municipal sources, if available, may be used through an agreement with the local water authority.

4.3 REVEGETATION MATRIX

A searchable *Revegetation Matrix* (Mandel, 2016a) is included as a supplement to this manual. The searchable matrix will be updated as necessary and as time and financial resources allow. The intent of the matrix is to provide a prioritized list of the major native plant species, and their attributes, used in the restoration of streambanks, flood terraces, and transitional zones in Colorado, including the Front Range. A total of 264 native species are presented within the matrix, including 81 woody species, 102 forb species, and 81 graminoid species. The prioritized species were determined through the Southern Rockies Seed Network, various government and municipal agencies (USFS, the NRCS, the BLM, state land management agencies, and local municipalities). The searchable parameters for each species include:

- ◆ Scientific name, common name, family, synonymy, and PLANTS code according to nomenclature as presented by PLANTS database (NRCS, 2016);
- ◆ Species priority for revegetation of flood-impacted areas;
- ◆ Growth Form, habitat, duration (annual, biannual, perennial), native status according to PLANTS database and Ackerfield (2015), and county occurrence and elevation according to Ackerfield;

- ◆ Colorado Conservation Status as indicated by Colorado Natural Heritage Program as well as NatureServe Explorer (NatureServe, 2016);
- ◆ US Army Corps of Engineers (USACE) National Wetland Plant List Indicator (NWPL) Status, according to Lichvar, Butterwick, Melvin, and Kirchner (2014), for USACE Regions *Arid West*, *Great Plains*, and *Western Mountains, Valleys and Canyons*;
- ◆ Ecological zone as defined by Hoag and Fripp (2005);
- ◆ Hydrologic preference;
- ◆ Successional stage (i.e., early-, mid- or late-seral);
- ◆ Nursery propagule, relative difficulty of propagation, and germination/vegetation propagation protocol;
- ◆ Recommended plant materials type (seed, container, division, cutting, etc.) for revegetation projects;
- ◆ Seed statistics: seed collection times, seed periodicity, average cleaned seed weight, length of seed viability under proper storage conditions;
- ◆ C-Value (Coefficient of Conservatism) according to Rocchio (2007);
- ◆ Tolerances and preferences for soil pH, slope aspect, shade, drought, soil texture, alkalinity, and sodicity;
- ◆ Root architecture and dimension;
- ◆ Nitrogen fixing capability;
- ◆ Wildlife and livestock usage and toxicity; and
- ◆ Extensive references as indicated by species.

One of the most important attributes presented within the matrix is species root architecture and dimension. Root architecture and dimension are extremely important for the determination of bank stability, resistance to erosion, and additive value of specific bioengineering practices.

4.4 CONCLUDING REMARKS

The knowledge required to successfully plan and carry out revegetation projects in a wildland setting is far greater than what can be included in this manual. Even under intensive agronomic settings, the vicissitudes of nature make good results challenging to obtain. However, given the relatively low cost of revegetation efforts for most stream restoration projects, and the integral role of vegetation in the

long-term resilience of a floodplain, it is prudent to invest in sound revegetation planning. For these reasons, it is highly advisable to engage a restoration ecologist in the planning stages of bioengineering projects and other floodplain restoration projects involving plant-based treatments. An additional resource for Colorado is the *Native Plant Revegetation Guide for Colorado* (Seiple, Clark, & Colorado Natural Areas Program, 1998).

5.0 PLANT-BASED BIOENGINEERING: TREATMENTS

This chapter describes how to apply plant-based bioengineering treatments in the context of a streambank restoration project, including tips to optimize vegetation survival within a semi-arid Colorado environment. While a broad range of plant-based treatments exists for consideration in floodplain and bank stabilization projects, this manual includes those treatments most applicable to Colorado streams and with the most proven performance in semi-arid environments.. Common goals to address with plant-based bioengineering treatments include:

- ◆ Reduced erosion potential;
- ◆ Increased bank stability;
- ◆ Improved water quality;
- ◆ Greater landscape aesthetics;
- ◆ Enhanced stability of physical structures;
- ◆ Improved terrestrial habitat value; and
- ◆ Improved stream shading.

It is important to note that availability of plant materials, whether as live cuttings, containerized materials, transplants, or seed, is an essential factor in the planning and implementation of bioengineering treatments. Because of the relatively limited amount of plant material currently available through the market, it is essential to determine the requisite species, quantities, and types (e.g., container, vegetative cutting, seed, etc.) of plant materials that will be required for a given project, and to pre-order these materials well in advance of project implementation. Much time is required to harvest and grow adequate seed, collect and grow containerized materials, and obtain the proper harvest/collection permits. Given these time constraints, one to three years advance notice may be necessary to obtain the desired quantities of plant materials. As such, proactive communication with nurseries during early planning stages of a project is required. Because of its long stem-length requirements, deep-rooted stock (i.e., three-foot long container) requires an even longer period (i.e., three to eight years) for cultivation. As consequence, deep-rooted stock needs to be reserved as far in advance as possible for a given project.

For a variety of reasons, the vast majority of native plant material on the market is either derived from locations beyond Colorado's borders (i.e., New Mexico, Washington, Montana), and hence is not locally adapted, or the origin of the plant material is not known. Absent proactive planning (including

contract growing) with nurseries, the practitioner may find themselves accepting native plant materials that might be in stock at a nursery at the time of purchase, but which may not be genetically suited to the project site. In this case, the practitioner runs the risk of obtaining plant material maladapted to local conditions, likely jeopardizing short- or long-term survival of those species necessary to meet design criteria.

5.1 LIVE CUTTINGS AND POLES

The planting of live stakes and poles involves the placement of dormant plant material in the riverbank to hold the soil in place and address other revegetation goals. To be successful, dormant cuttings (stakes, poles, whips, etc.) should be installed according to the following criteria:

- ◆ Must be able to withstand hydraulic stressors impacting the portion of the bank in which they are installed;
- ◆ Temporary roots must be able to reach lowest seasonal ground water table until their permanent roots are established;
- ◆ At an appropriate planting density for the treatment being utilized; and
- ◆ Should be sourced from areas of similar habitat as where the bioengineering work is taking place.

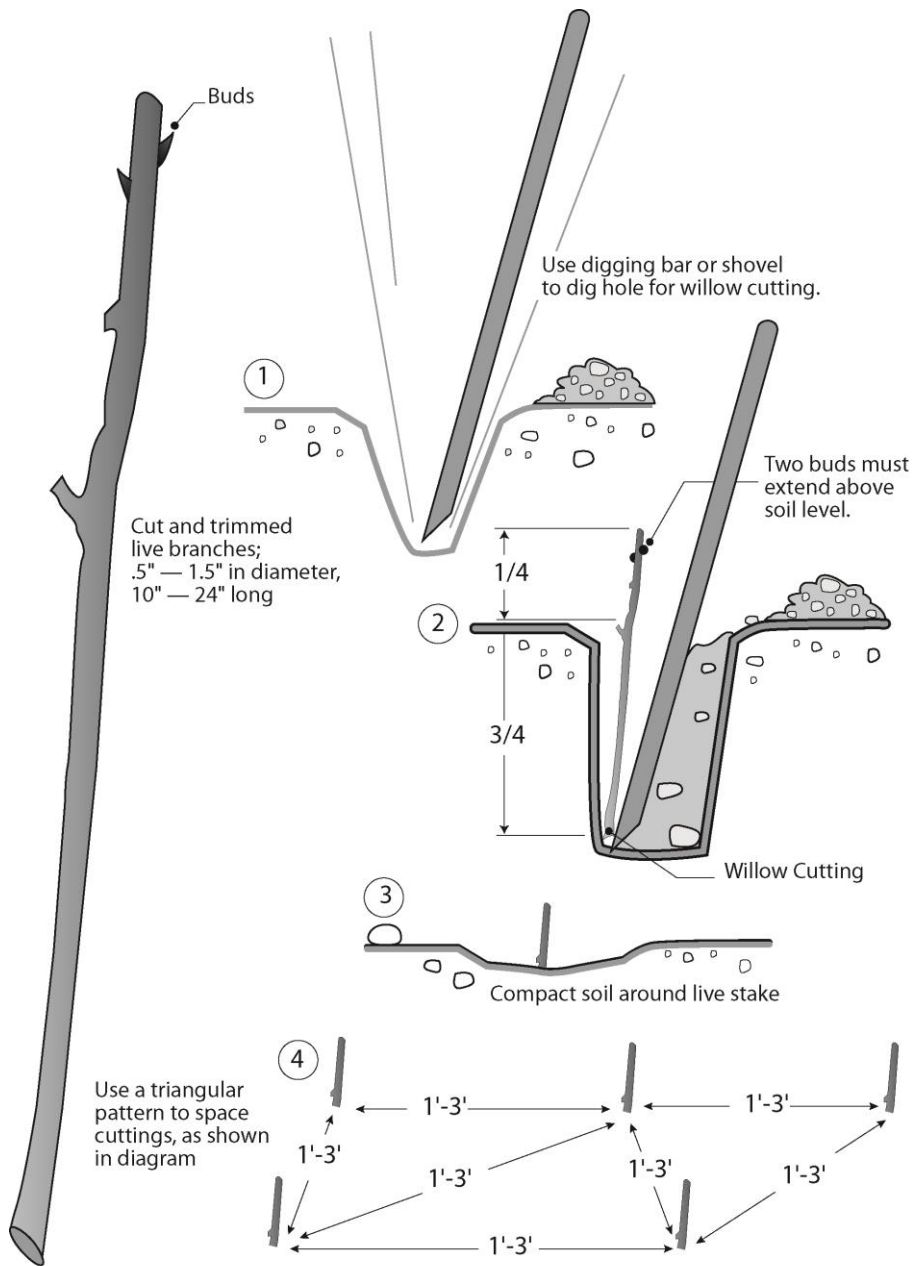

Figure 8. Live Cuttings. (Adapted with permission from Eubanks & Meadows, 2002)

As shown in Figure 8, cuttings may be placed on 1- to 3-foot centers, which translates to between 5,578 and 51,000 plants/acre using a quadratic formula (1.15 plants/ft^2) for spacing determination (Mandel, 2016b). Depending on the treatment to be used, and site conditions, a variety of installation patterns may be used. A summary of the procedures for selection, harvesting, and installation of a variety of live cutting materials are presented below. The reader is referred to Appendix A for the companion "Field Guide for Harvesting and Installing Willow and Cottonwood Cuttings" for more complete harvesting and installation details.

Mechanism and Optimization

Upon proper installation, a live cutting will begin to grow new roots and buds. Growth of fibrous roots into a network is also known as a *root ball*. Fundamentally, it is the combined parameters of root tensile strength and the root ball dimension that determine a plant's ability to impart erosion resistance. Consequently, plants with fine roots and a large root ball diameter are best able to enhance bank strength and surface erosion resistance. The plant must be able to withstand the anticipated shear stresses of the riparian zone in which it is installed. Previous chapters provide estimates of the range of shear stresses that some typical plants can withstand, and describe how to approximate the shear stresses a particular location within a cross section may experience.

Live cuttings can be installed in multiple settings and configurations. They can be planted as individuals that range in size, depth, and location, or they may be combined to create bundles, woven into mattresses, or integrated with structural-based elements. Several of these configurations are discussed below. The following tips pertain to all types of dormant cuttings:

- ◆ Cuttings have the greatest chance of survival if harvested while dormant;
- ◆ Cuttings benefit from soaking from seven to 14 days prior to installation, depending on the species, age of harvested material, ambient temperatures, and site conditions following installation (Figure 9);
- ◆ Cuttings should be harvested from actively growing shoots of vigorous, disease-free and insect damage-free trees. Harvested shoots should be free of sooty fungus as well as scars and blemishes. In general, 2 to 5 year-old cuttings tend to yield the most vigorous materials;
- ◆ Harvested species must have the ability to form adventitious tissue (i.e., the ability for a given bud to form either an above-ground shoot or root);
- ◆ Use ethical harvest guidelines and acquire a proper collection permit prior to harvest; and
- ◆ All dormant cuttings should be planted in a manner that maximizes soil-stem contact, with proper tamping and subsequent watering to remove air pockets and to promote uniform and reliable access to ground water.

In general, harvest of cuttings is preferred over harvesting whole plants due to ease of harvest and reduction in damage to donor stands. Of Colorado's flora, native willow,



Figure 9. Pre-soaking willows and cottonwoods at Skin Gulch, CO. From Voigt, D. Reprinted with permission.

cottonwood, and red osier dogwood are the most commonly used plant species for dormant cuttings due to their ease of rooting, tolerance to saturated soils, and preference for periodic inundation (Hoag & Landis, 2001). The use of stooling blocks and “mother” plant propagation treatments is a recommended approach to developing adequate quantities of cuttings, rather than wildland collection. Reasons include ease of propagation, higher survival rates, and reduced stress to donor stands. If wildland harvest proves necessary, it is recommended harvest locations be in close proximity to the project site. Stooling blocks and nursery produced materials must be closely monitored for genetic integrity, drift from wild-collected populations, insect/disease/browse, invasive species, and general vigor.

Harvested materials need to represent the natural range of species and genetics that typify a given site, as determined by reference reaches that either remain within isolated pockets within a given watershed, or in neighboring watersheds of similar physiographic influences, elevation, aspect, and geography.

Ethical Harvesting Guidelines

To protect the health of donor stands, it is essential the practitioner adhere to ethical harvest guidelines. For willows and cottonwoods, no more than 30% of a stand should be harvested, with no more than 15% of cuttings harvested from an individual plant. Additionally, to maintain genetic diversity and improve the likelihood a good balance of male and female plants (e.g., species within Salicaceae are dioecious, with male and female flowers occurring on different individuals) are collected, a harvest should include at least 30 individuals from a wide (i.e., an entire valley) geographic distribution. In areas of critical wildlife concerns (i.e., Preble’s Meadow Jumping Mouse habitat), no more than 10% of a stand should be harvested. In critical habitat areas, permission from US Fish and Wildlife Service (USFWS) or other authorities may be required prior to harvest. For a complete guide to ethical harvesting, refer to “Guidelines for the Ethical Harvest of Plant Materials” (Southern Rockies Seed Network, 2015).



Figure 10. Willow stakes ready for installation. From Blazewicz, M. J. Reprinted with permission.

Cuttings and Live Stakes

Cuttings (i.e., live stakes or whips) consist of straight hardwood stems of live plants, commonly willow and cottonwood in Colorado. Dormant woody materials should be harvested as described in the “Field Guide for Harvesting and Installing Willow and Cottonwood Cuttings” (Giordanengo and Mandel, 2015), Appendix A. Stakes should be of an adequate length to reach six inches into the low-season water table, with enough stem remaining such that no fewer than three to four live buds remaining above the ground surface.

Live stakes are typically larger diameter cuttings, usually from 1 to 2 inches in diameter (Figure 10). They are used to establish individual shrubs or to anchor fascines and wattles. Live cuttings are integrated into a wide variety of

other bioengineering structures. Whips are typically younger material, about ¼ inch to 1 inch in diameter, and are used primarily in fascines, as individual cuttings, or joint plantings and similar treatments.

Pole Planting

Hardwood poles are long, relatively large diameter (i.e., greater than 2 inches in diameter) single dormant cuttings. Hardwood poles (typically cottonwoods) are primarily used to:

- ◆ Provide greater tensile strength required for specific bioengineering structures, as compared to smaller cuttings; and
- ◆ Allow practitioners to plant cottonwoods, in the form of 6-foot or longer poles, further from the water source than would be possible using smaller cuttings, effectively “widening” the riparian planting zone while still allowing the cutting to reach the water table.

Poles (also called posts) are installed approximately perpendicular to the groundwater surface with their base reaching below the low season water table and their tops protruding above the surface by up to 5 feet. Pole planting is normally done with a *stinger* (i.e., deep-reaching hydraulic probe or manual probe) that is mounted on a suitably robust backhoe (Figure 11). If using a stinger-type planting device, it is important (as in all cuttings) to penetrate the groundwater with the tip. The planted pole should be inserted the entire depth of the hole to avoid air pockets. Upon planting, any remaining air-pockets should be backfilled with an appropriate soil slurry and settled with adequate irrigation. General installation dimensions are illustrated in Figure 12.



Figure 11. Mechanical stinger probing into the groundwater for willow installation on Tarryall Creek, CO. From Giordanengo, J. H. Reprinted with permission.

LIVE POSTS

(Not to scale)

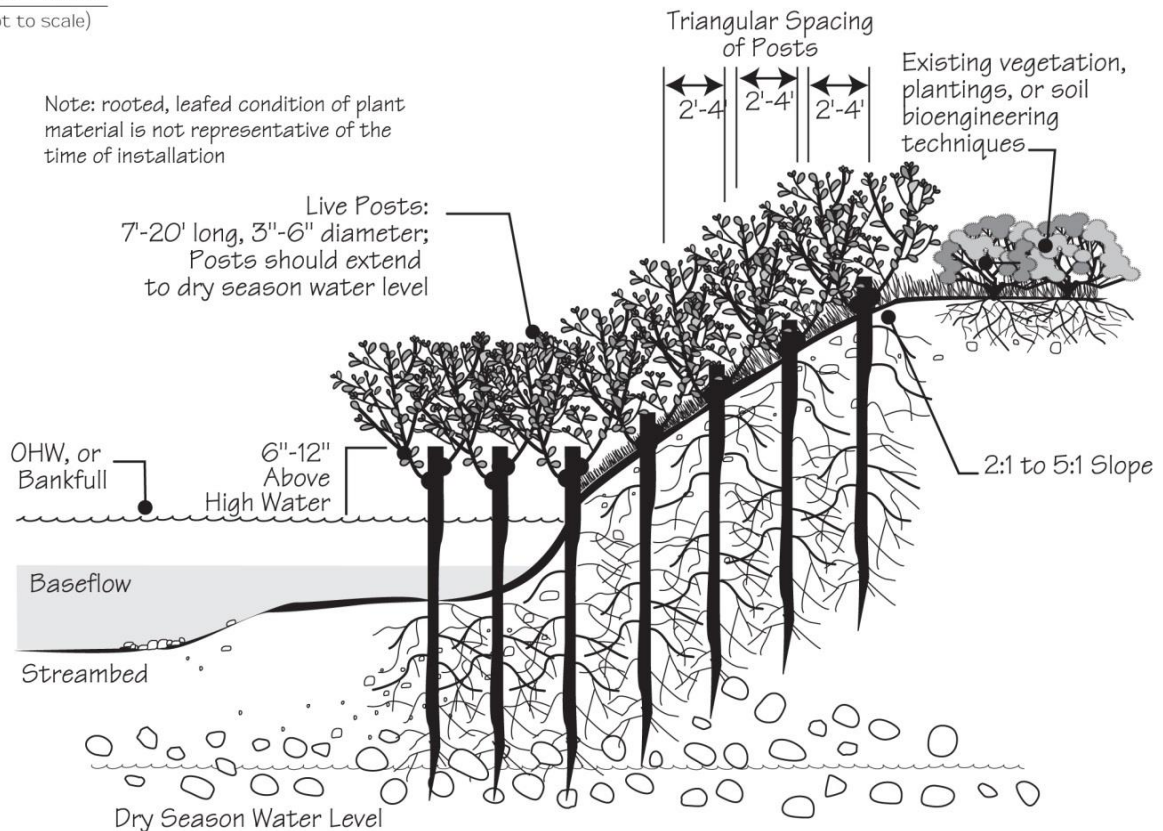

Figure 12: Pole Plantings (Reprinted with permission from Eubanks & Meadows, 2002). [Ed. NOTE: Drawing is significantly disproportional]

Other Plant Materials

Nursery Plants

Nursery plants can include a variety of container materials, bare-root stock, ball-and burlap, and others. As mentioned previously, nursery stock should be derived from site-specific native plants (i.e., *ecotypic*) that represent the expected level of species diversity exhibited in reference sites. Ecotypic plant materials have improved chances for survival and genetic fit as they have evolved under the same selective pressures as are present at project site. As result, ecotypic plants demonstrate similar patterns of resistance and physiographic preference to the surrounding native vegetation, as well as improved genetic fitness (i.e., ability to respond favorably to biotic and abiotic stressors over time). Through fitness, ecotypic materials are able to provide increased resiliency through improved survival, reproduction, and vigor, as well as proper integration into the ecological functions and services that are inherent to a natural plant community.

Bare-root stock

Numerous studies and field trials, including the USDA NRCS Plant Materials program, have shown nursery-produced *bare-root stock* (i.e., provided without container and surrounding soil) to yield reduced survivorship in comparison to containerized stock (i.e., plants potted in soil with well-established rootballs). Bare root stock typically have shallower root systems in comparison to containerized stock. Furthermore, washing of roots, a practice necessitated by the storage and distribution of bare-root stock, results in a loss of beneficial soil symbionts (i.e., nitrogen fixing bacteria and/or mycorrhizal fungi that enhance nutrient uptake by roots) from the rootball (Seiple et al., 1998; St. John, 2000). Additionally, due to their lack of containerized protection, bare-root stock should be handled with additional care to minimize damage and desiccation (Seiple et al., 1998) during transportation and staging plant materials prior to installation. To compensate for these conditions, care for bare-root stock should include constant shade, maintenance of moisture around roots, and addition of native soil as an inoculum to water (i.e., do not use water alone) while roots are being soaked in buckets.

Due to their reduced root systems, nursery- or greenhouse-derived bare-root stock are slower to establish, are best planted while dormant, and require moist soils or artificial irrigation for successful implementation (Seiple et al., 1998). While bare-root materials may initially appear more economical in comparison to containerized materials, initial benefits prove short-lived when considering reduced survivorship and the secondary implementation costs associated with replanting.

Wildland Harvested Transplants

It is important to distinguish between bare-rooted nursery stock (that is nursery-lifted or greenhouse-harvested and then shipped to its end-point of use), versus wildland-harvested transplants from ecologically similar sites. Wildland-harvested transplants installed with a minimum amount of disturbance to their soil rhizosphere have been successfully implemented in multiple projects (Seiple et al., 1998). As with all live plant material collection, it is essential to obtain proper permitting prior to the field harvest of wildland stock and follow ethical harvest guidelines. The benefits of using wildland harvested transplants include:

- ◆ Use of ecotypic plant material and associated soil biota (i.e, beneficial mycorrhizal fungi);
- ◆ Rapid establishment of above- and below-ground plant material; and
- ◆ Acquisition of diverse plant materials that may otherwise be unavailable in the marketplace.

Drawbacks to the use of wildland harvested materials include: (a) difficult to harvest sufficient quantity of rhizosphere for some deep-rooted species; (b) high cost of excavation and transportation to work site; and (c) possible negative impacts to donor stands.

Container stock

As compared to bare-root materials, the benefits of containerized plant materials include intact, fully functioning and protected root systems, greater resistance to damage during transportation and staging, and enhanced symbiotic microorganisms (if properly inoculated). As such, containerized stock, in comparison to bare-root stock, generally have:

- ◆ Deeper root systems;
- ◆ Increased survival after transplant as a consequence of reduced root disturbance;
- ◆ Increased likelihood of inoculation by beneficial soil-borne organisms;
- ◆ Greater suitability to planting throughout the year as allowable by site moisture conditions, versus just when dormant; and
- ◆ Less fragile handling requirements in comparison to bare-root stock (CNAP, 1998).

Like bare-root stock, container stock is often used to help diversify a seeding effort, thereby helping to set a given project on the proper plant community trajectory over time and imparting a greater number of ecological functions and services to a site. Examples include planting woody species (i.e., thinleaf alder, western river birch, or black chokecherry – *Prunus virginiana* spp. *melanocarpa*) and a wide range of forb species to benefit macroinvertebrates, Neotropical migrating birds, and other wildlife—including pollinators.

Containerized plants benefit from at least a two-week field-hardening period between exiting the greenhouse and prior to transplanting into the restoration site. During the hardening period, plants should be exposed to increased solar radiance, decreased watering frequency, reduced fertilization, and similar conditions (i.e., elevation, temperature, wind, etc.) to the project site.

In general, containerized stock is available in three sizes: plugs (i.e., 4-cubic inch, 10-cubic inch, etc., or F-27 or F-32 flats); medium-sized containers (i.e., 1-quart, 40 cubic inch tube, 1-gallon, 14" deep-pots); and large-sized containers (i.e., 5-gallon+, and deep-pots/tall-pots). Small containers such as 10-cubic inch plug (e.g., 10-cubic inch supercells) are commonly used for producing containerized graminoid species such as upland grasses or hydrophytic sedges, or forb species.

The advantages of small containers, in comparison to larger containers, are:

- ◆ Reduced price;
- ◆ Reduced production time (within 1-growing season);
- ◆ Reduced cost of transport to the project site;
- ◆ Increased transportability at the project site, reducing installation costs and time; and
- ◆ Efficient planting (e.g., ability to plant a greater number of plants per hour using tools such as planting “dibbles”, “sharpshooters”, or “hoedads”).

Due to the low soil moisture conditions found in so many Colorado restoration sites, efforts should be made to use larger and deeper-rooted container plants. Besides the many benefits imparted by deeper root balls, in comparison to 1-gallon pots, deep-rooted containers (i.e., 40-cubic inch and similar containers) offer greater ease of transport to and within the field due to the narrower container diameter.

The concept of deep-rooted containerized planting stock was originally conceived at Joshua Tree National Park. At Joshua, drought tolerant plants were grown in especially long (i.e., up to six feet in depth) containers to promote access to deeper water tables and to reduce their required frequency of irrigation. Within the last ten years, the NRCS Los Lunas Plant Materials Center and the Tamarisk Coalition have been adapting this concept for Colorado through the development of woody riparian stock from adventitious-rooting species (i.e., *Salix* and *Populus* spp.), which can be planted deep enough to reach the capillary fringe. Once planted, adventitious roots form up the length of the stem, providing more rapid colonization of a given soil profile and an increased bulb dimension. Because deep-rooted stock can typically be planted directly into the capillary fringe, they tend not to require subsequent irrigation in semi-arid environments and are able to immediately colonize the rooting profile.

Deep-rooted containers have the advantage of immediately providing rooting stability into a soil matrix. Hence, they have historically been installed in difficult or highly erosive systems, or into areas where subsequent irrigation would otherwise be required. Deep-rooted containers have the additional benefit of offering the designer to incorporate planting zones higher above the normal water line, away from scouring flows, and still maintain the ability of the rootball to reach the capillary fringe. Because of their lengthy time requirement for production, deep-rooted materials tend to be expensive, must be reserved between two and five years in advance of a given project, depending on actual root depth desired, or obtained from ready-market sources. Fourteen inch deep containers can be produced as quickly as 6 months for many species.

Large containers, such as five-gallon, 10-gallon, etc., are normally reserved for larger trees, such as cottonwood species or conifers. Typically, they are planted in municipal settings due to their increased acquisition, implementation, and transportation costs. When utilized in restoration plantings, however, such large containerized plants can add dimensionality to a site in terms of vegetation height, plant community function, and root-bulb dimension. Additionally, these larger materials have the ability to more rapidly provide bird perches or windbreaks, in comparison to smaller container types. Because large containers may take from three to five years to produce, they must be reserved in advance of a given project.

Regardless of rootball dimension, containerized materials must be planted into appropriate soil moisture conditions to ensure survival. When planting in drier upland soils, containerized materials can be more successfully established if irrigated at the time of planting as well as following installation. Building a “watering depression” around the plant (i.e., from the excavated soil), and use of proper mulching (i.e., up to two inches deep around the base of the plant within the depression), will help to increase survival and reduce the frequency of irrigation.

Clump Planting

Clump Plantings are accomplished by excavating and transplanting large, field collected plant material with the above-ground, below-ground and soil systems intact. Clumps are normally excavated from a large stable willow stand, or from stands on site during bank and channel realignment work. Materials are obtained with a backhoe or bucket loader, with care to ensure that the equipment is not so large that it will cause unacceptable damage to the “borrow-area.” Growth of clump plantings can show a high success rate. This success in comparison to other plant materials is due to the immediate presence of the clump planting’s entire biomass (roots, stems, and leaves) as well as the native soil and associated soil biota around the rootball. Clumps are placed where most effective and needed – usually an area requiring rapid protection. Due to the large clump size and their requisite location in wetland areas, appropriate 404 permitting through the US Army Corps of Engineers will be required.

Do not take willow stands from critical areas that may cause excessive erosion. Plant excavation should be done in a manner that impacts less than 30% of a given area. Excavation should be carried out in a vertical manner that leaves an approximately 10-inch gap around the willow stems. The goal in doing so is to obtain approximately 70% of the available root biomass for a given plant.

The excavated clumps are planted into a pre-dug hole just above the water table with saturated soil at the bottom. Usually, clumps are planted close together with soil from the banks used to fill between clumps. Temporary fortification such as jute netting can be placed to hold clumps in place and large rocks can be used to stabilize and protect clumps from water scour. Fill any air pockets in the clump with a slurry of soil and water. Trim about 1/3 to 1/2 of the tops of the willow stems to reduce transpiration. Refill the borrow areas with good quality soils and repack with the excavation

equipment. Borrow areas should be revegetated through vegetative transplants of hydrophytic graminoids (e.g. *Carex* sp.) and/or with site-specific willow stakes.

5.2 STRUCTURES INVOLVING MULTIPLE CUTTINGS

Generally, treatments that involve groups or bundles of cuttings are either placed horizontally along the bank face to prevent surface erosion, or perpendicular to flow to increase bank strength. Biodegradable twine, rope, and stakes are preferred over metal or plastic materials in order to reduce potential trash problems or hazards to humans or wildlife. As noted earlier, multiple sizes and configurations of woody materials can be used within the same planting area to diversify rooting depth and to provide a “mosaic” approach to further extend limited plant materials availability, or financial and temporal resources.

Fascine Bundles

Fascine Bundles (i.e., fascines), similar to willow wattles, are bundled cuttings of willows or cottonwoods, bound together with twine or wire. Fascines are one of the primary tools for river restoration. Fascines can provide both erosion control and structural functions, both individually and as constituents of more complex treatments.

CROSS SECTION:

Not to Scale; Mature, leafed-out condition depicted

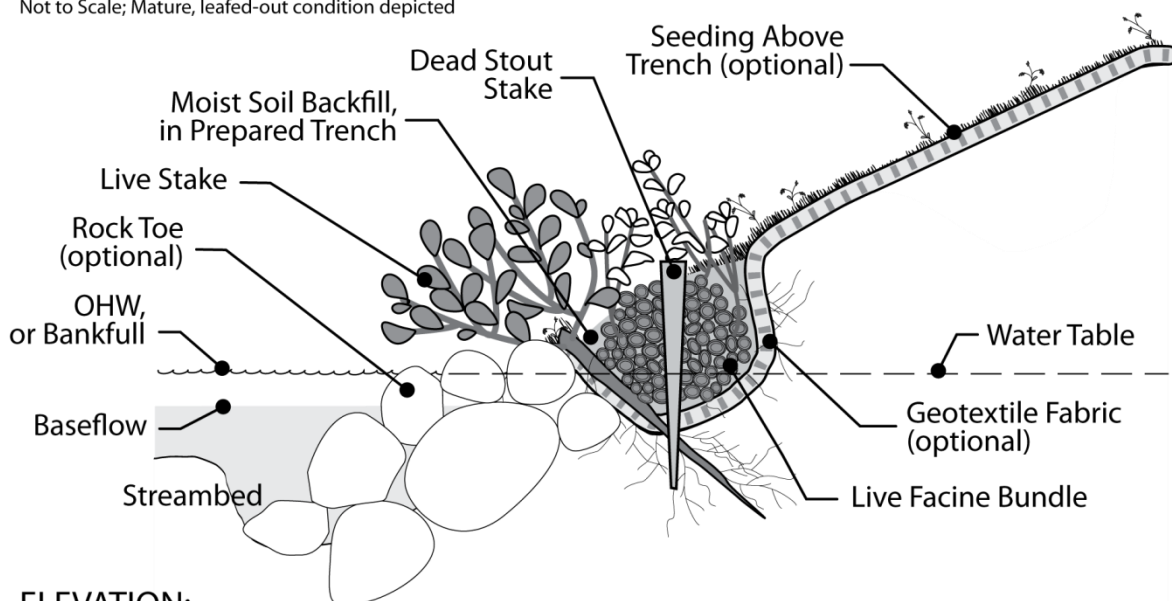

ELEVATION:

Not to Scale; Immature condition, at time of installation, depicted

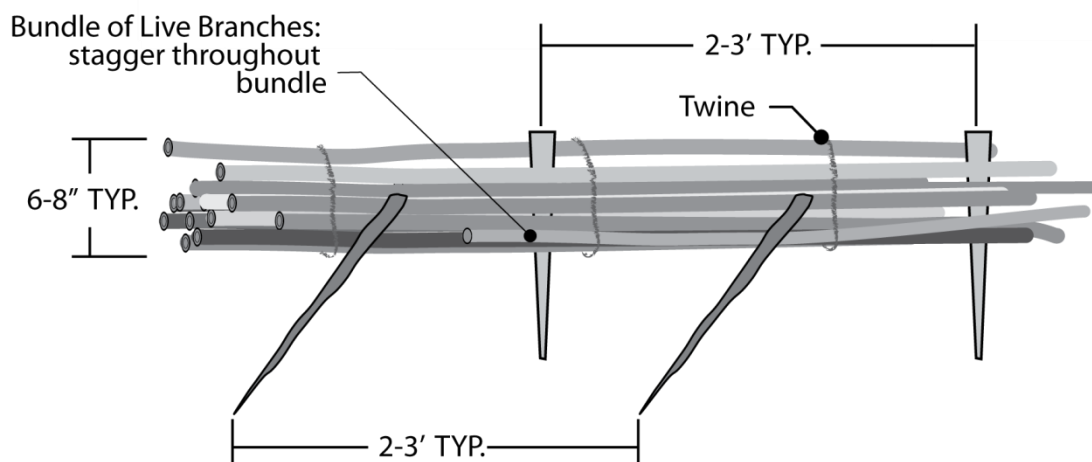

Figure 13: Fascine Bundles (Adapted with permission from Eubanks and Meadows, 2002)

Figure 13 is a standard representation of fascines, installed parallel with the water elevation to reduce scour at the toe zone. The erosion control function of a fascine bundle in the short term is provided by the lateral woody material of the stakes within the bundle, imparting roughness to the surface, thereby slowing down overland flow velocities. Over the long-term, fascines impart significant bank strength resulting from the interconnected nature of the root network that grows as they develop, and the reduced shear stress imparted by their extensive above ground canopy. As a practice, however, fascines are rarely applied as a standalone treatment to improve bank strength. For successful establishment, a fascine requires adequate soil moisture and predictable hydrologic conditions. This can often be achieved via proper placement relative to known hydrologic regimes. When fascines are placed too close to the baseflow elevation, they are likely to be lost. In arid- and semi-arid sites, when fascines are placed too far above the toe zone they will likely lack the levels of soil moisture necessary for production of adventitious roots from the willow cuttings. Fascines are typically installed

in shallow trenches, either alone or in interconnected bundles depending on the length of bank requiring protection. When orientated along the contour, fascines serve a function similar to wattles (covered in a subsequent section), decreasing erosion potential from overland flow. Fascines may also be oriented perpendicular to the contour in order to provide protection higher up the bank zone.

In either orientation, interconnected bundles are constructed by laying individual cuttings in an overlapping pattern within the trench, and then encircling and binding the bundles together with cord or wire (Figures 13 and 14). In this manner, a single bundle measuring one hundred feet long could be constructed from willow cuttings that are only three to six feet long. This continuous bundle provides a better anchor than would several smaller, shorter bundles. The completed bundles must be anchored in place, using either dormant willow stakes or manufactured wooden stakes (Figure 13). The completed bundle is backfilled with soil in a manner that eliminates air pockets and ensures proper soil to stem contact. A portion (less than 25%) of the bundle should be left exposed above the soil surface to facilitate bud-break and subsequent growth, and to intercept overland flow.



Figure 14. Fascine prior to staking and backfilling, Little Deer Creek, CO. From Giordanengo, J. H. Reprinted with permission.

Brush Layering and Brush Packing

Brush layering is a technique used in slump areas that require erosion protection. This treatment reinforces a portion of the bank through the placement of sequential layers of cuttings and soil (Figure 15). The exposed branches will trap sediments and provide soil surface protection, while the growing roots provide subsurface bank stability.

Brush packing differs from brush layering in that structural reinforcement is added via vertical pole plantings. The vertical poles are installed in a planform grid pattern such that the bottom of the poles penetrate into the undisturbed material below the void being filled, leaving the tops of the poles protruding above the ground surface. The added strength of the poles decreases the potential for subsequent lateral slope failure. Layers are formed by placing repeated layers of rock and soil into the excavated site, followed by a four- to six-inch layer of crisscrossed living branches. The layering is repeated until the desired contour is reached. Care should be taken such that soil compaction levels do not result in conditions that will inhibit root growth.

CROSS SECTION:

Not to Scale; Mature, leafed-out condition depicted

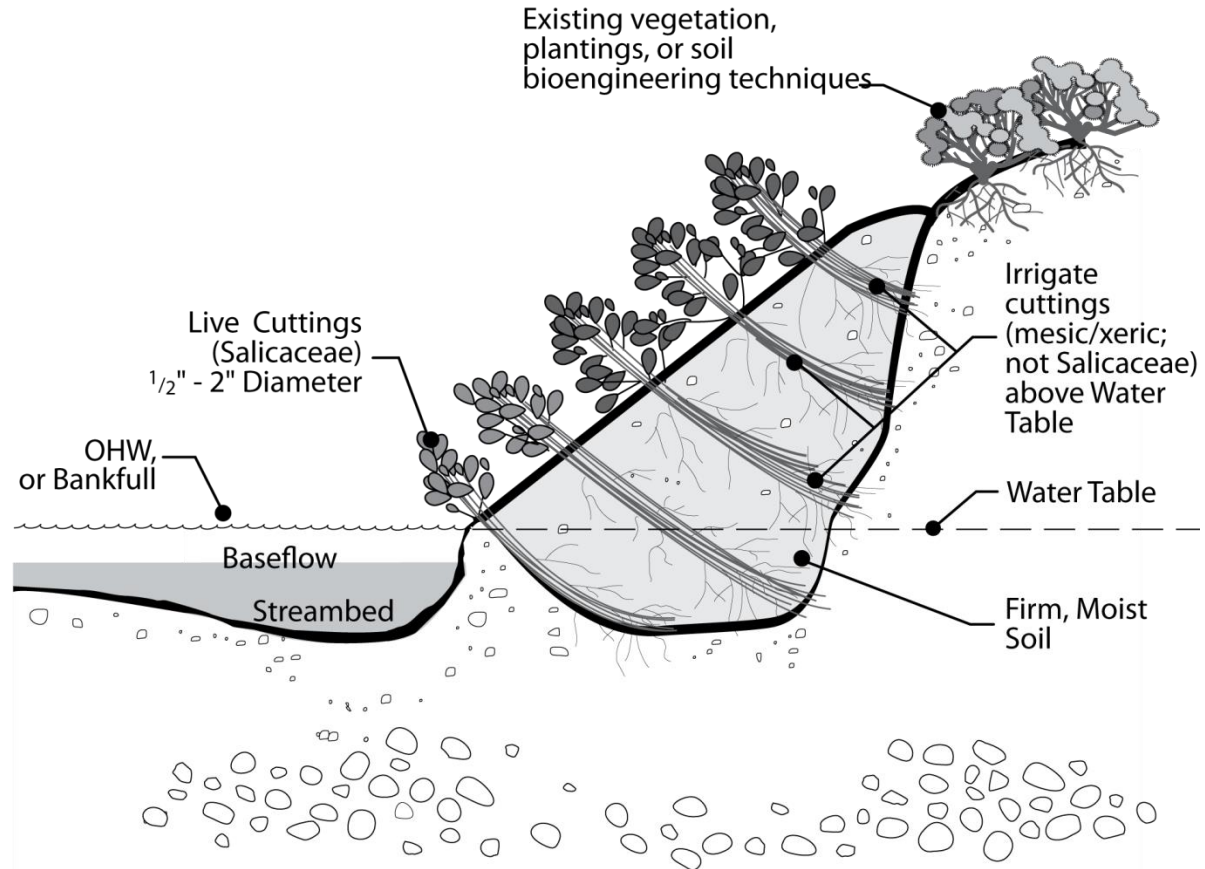

Figure 15: Brush Layering (Adapted with permission from Eubanks & Meadows, 2002).

Trenching

Also known as *brush trenching*, *trenching* consists of creating a contour trench at the top of the bank and packing it with willow cuttings or other brush. The trench serves to intercept surface runoff (i.e., in the form of rill or sheet erosion) from adjacent upland areas, thereby decreasing the potential for erosion of the bank zone below. In this manner, trenches can provide protection for transplants and seedlings on the bank below. Stems one to 1.5 inches in diameter should be selected for fill. If the trench is of an appropriate location on the slope, poles or longer willow cuttings may be installed through the bank and into the groundwater, providing enhanced protection via long-term vegetative growth. Trenches should not be located at or below the bankfull elevation.

Brush Mattressing

Brush mattressing is intended to decrease the potential for surface erosion by covering a slope with a single layer of cuttings approximately six to 12 inches thick. Cuttings are secured by stakes and cord, as shown in Figure 16. The brush mattresses are placed above the bankfull line to assist in the capture of sediment during flood conditions. The branches for the “mattress” should be cut six to nine

feet long, and be flexible enough to conform to the contours of the treated area and allow good soil to stem contact.

CROSS SECTION:

Not to Scale; Mature, leafed-out condition depicted

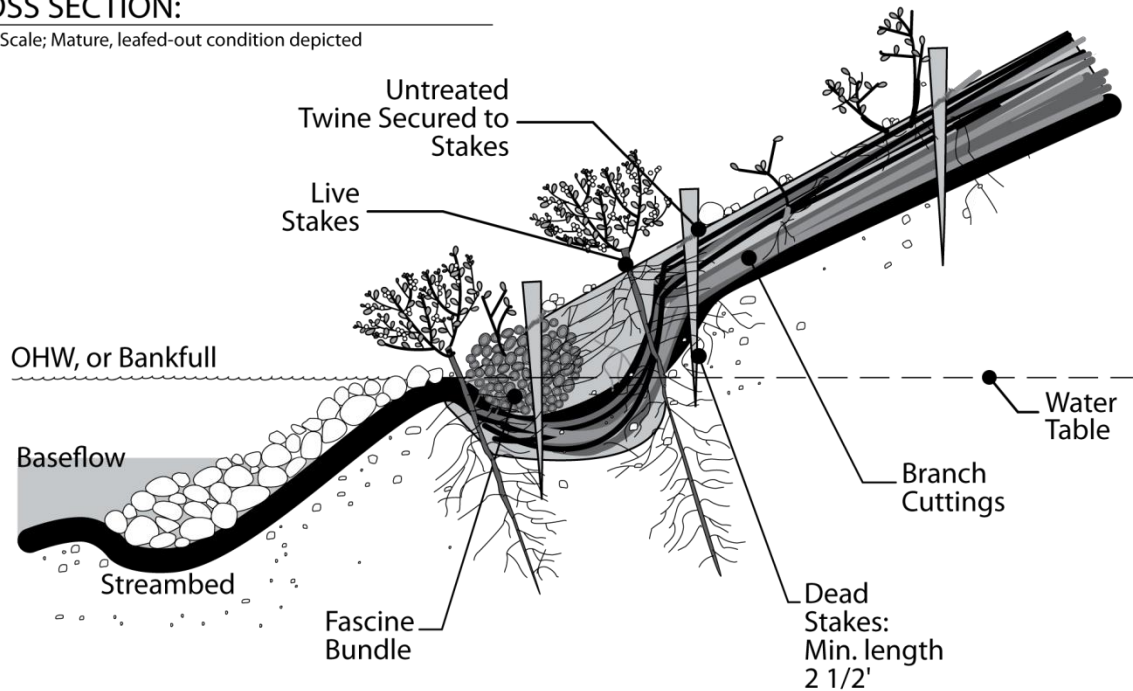

Figure 16: Brush Matting (Adapted with permission from Eubanks and Meadows, 2002)

5.3 OTHER PLANT-BASED EROSION CONTROL TREATMENTS

Coconut Fiber Rolls

Also known as *coir rolls*, *coconut fiber rolls* are long cylindrical structures composed of coconut husk fiber bound together with twine or synthetic rope. They are available in varying lengths, diameters from six to 20 inches, and densities from five to nine pounds/cubic foot. Typically, they are 100% biodegradable, and should be used only in areas where long-term toe protection is not essential to bank stability. Coconut fiber rolls are typically applied at the toe of shallow slopes where stream power and shear stresses are low, or on lake shorelines to minimize wave-caused erosion. The best long-term results are accomplished when vegetation is planted into the roll. It is becoming more common to use coconut fiber rolls with wetland plugs pre-installed. Seed may also be integrated with the log, as can be live willow or cottonwood cuttings. Refer to Figure 17 for general installation overview.

CROSS SECTION:

Not to Scale; Mature, leafed-out condition depicted

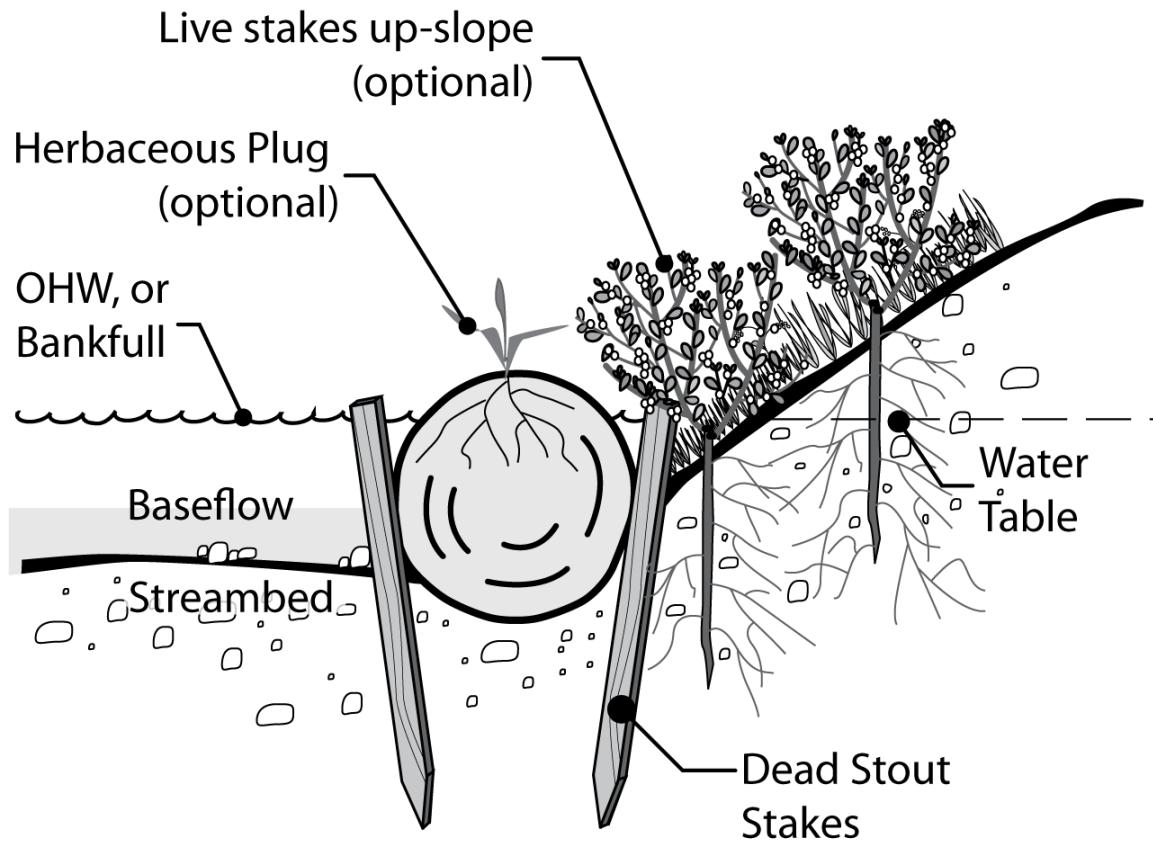

Figure 17: Coconut Fiber Roll (Adapted with permission from Eubanks & Meadows, 2002).

Seeding

For bank zones, transitional zones, and adjacent upland zones, hand broadcast seeding is an effective means of covering large disturbed areas. Seed should be surface-applied through hand broadcasting at a rate based on the number of pure live seed (PLS) desired per square foot of planting area. Typical seeding rates range from 40 to 120 PLS per square foot, depending on species used and method of seeding (i.e., drill or broadcast). Following seeding, the ground is hand raked (or mechanically raked if topography allows) to cover seed to a depth of $\frac{1}{8}$ - to $\frac{1}{4}$ -inches. Covering seed will minimize seed losses from herbivory, heat-induced degradation, or translocation from wind or water erosion. To ensure good seed-to-soil contact, the seeded area may be slightly compacted through a water-filled press-wheel. All seed must be labeled as “certified” by the Colorado Seed Growers Association, and should not include the presence of noxious or invasive species prohibited under the Colorado Seed Act. As disturbed ground is highly favorable for the majority of invasive species, it is advisable that a “zero weed tolerance” rule be used for seed mixes (i.e., no noxious or invasive species included in the mix).

All seed must be inspected by the installing contractor prior to installation, and all tags must be maintained for documentation. Due to the nature of agriculture, there will typically be some quantity of invasive species seed in the ordered seed mix. Ensuring the seed label reads “Noxious: none” is a first step. Due to the nature of the Colorado State Seed Act, a seed mix may still contain seeds of noxious or invasive species like cheatgrass, even though the label reads “none”. Before ordering seed, review the seed analysis for each seed lot in order to understand the extent of invasive species seeds occurring in the seed mix. Types of invasive seed that may be found in the seed analysis include “crop”, “weed”, and “noxious”. Any of these may constitute what the practitioner considers to be a “weed.”

As seed can naturally lose its viability over time, even under proper storage conditions, it is advisable to use seed that is less than three years old. Detailed information concerning average seed weight and recommended seed storage time-period is included within the Restoration Matrix provided as an electronic appendix to this manual. Preferentially, seed sources should be ecotypic. If ecotypic seed is unavailable, it is advisable to work with a knowledgeable restoration ecologist to identify the most appropriate native plant cultivars (e.g., cultivated varieties of native plants) for your site.

Due to the erodible nature of streambanks, and the vulnerable nature of disturbed soils in general, seeded areas should be protected with erosion matting or mulch, as described below. Scoured and/or regraded streambanks are often lower in fertility than undisturbed soils that have developed under the periodic deposition of nutrient rich floodwaters that typify many riparian areas. While seed mixes typically include a high proportion of early-seral species adapted to poor soil conditions, there are instances when soil amendments may be required to meet revegetation needs.

Soil Amendments

Before soil amendments are designed for a given project, soil fertility and other soil conditions (pH, electrical conductivity, soil carbon, trace minerals, etc.) should be determined through soil testing through an approved laboratory. In highly disturbed soils, organic matter is often lacking to a degree that revegetation goals will be difficult to attain in a timeframe appropriate for project planners. While a variety of soil amendments may be applied to remedy this situation, care must be taken to ensure more good than harm is accomplished with the amendment(s) in question.

Caution! A great number of invasive species are stimulated by high nitrogen content! Use care when developing soil amendments, especially

Humate

In areas where sufficient soil organic matter is lacking, the addition of *humate* (i.e., humic acid in a solid form) at a rate approximately one to two percent by volume of the soil matrix will improve soil organic matter content. Improving soil organic matter content enhances the soil microbial community, improves soil moisture retention, and increases nutrient holding capacity of the soil (Seiple et al., 1998). Should additional organic amendment be required, it is recommended that additives be low in

nitrogen and of a slow release variety. Depending on the organic product, it may be topically applied or incorporated into the soil through “disking” or “ripping” to a depth of three to six inches.

Compost

Compost is another soil amendment that should be considered in plant-based bioengineering treatments. It is a common misconception that compost is high in nitrogen. While some compost products may be high in nitrogen, well-composted organic matter is often low in nitrogen, and high in organic matter and associated beneficial soil biota. Compost, at an application rate appropriate for your site, should be incorporated (disked, tilled, or ripped) into the top three to six inches of soil, and not left on the soil surface. Because compost derived from dairy manure can be very high in salts, and given the wide range of compost products available commercially, it is essential to ask the supplier for lab results listing the nutrient status, salt, organic matter content, and other chemical constituents associated with the product in question.

As there is often overlap in the nutrient and organic contents of various soil amendments, soil fertility and soil amendment plans should consider the combined effect of all soil amendments rather than considering each amendment on its own merit. For instance, Biosol (a slow release organic soil amendment with a moderate level of total nitrogen) also contains humic acid. Likewise, compost contains high levels of humic acid. Thus, in most cases combining Biosol, humate, and compost does not constitute a wise use of budget.

Soil Fungi Inoculation

As discussed in previous chapters, symbiotic, beneficial soil organisms (such as site-specific mycorrhizal fungi) benefit plant establishment in several ways. These benefits are greatest when utilizing local, native mycorrhizal fungi. In contrast, introduced mycorrhizal fungi can outcompete native mycorrhizae populations, and possibly hinder establishment of the desired fungi or prove to be a poor use of budget. Incorporation of mycorrhizal fungi should be based upon:

- ◆ The size of the area being restored, as small areas surrounded by extensive native populations are likely to be inoculated naturally by the adjacent undisturbed sites;
- ◆ The species being used for restoration, with groups such as conifers showing the strongest benefit;
- ◆ Project budget, soil amendment needs, and priorities; and
- ◆ Whether plant materials have previously been inoculated by the providing nursery.

Soil surface protection

Disturbed soils are highly susceptible to evaporative losses, wind erosion, water erosion, and heat stress, each of which are deleterious to plant establishment. A variety of materials may be used in combination with plant-based treatments to reduce these environmental stressors and facilitate successful plant establishment. Including measures such as mulch, rock, erosion matting, hydro-mulch, and other geotextile materials during the vulnerable post-construction establishment phase will provide protection against erosive forces until desirable vegetation becomes established.

Erosion Control Blankets and Geotextiles

Erosion control blankets (ECBs; also referred to as *erosion matting*), mulch, and a variety of *geo-textile* materials (i.e. a variety of polypropylene or polyester fabrics) are used to reduce potential surface erosion and enhance soil moisture retention during plant establishment. The ECB is anchored to the ground surface via live or dead stakes, or manufactured landscape staples, to reduce the effects of raindrop splash, retain soil moisture, reduce wind and water erosion, and in some cases reduce scouring effects of flowing water. ECBs come in many forms and materials and serve different purposes. Straw ECBs are usually intended to provide erosion protection from precipitation and are suitable for upland sites (e.g., they are not intended to remain submerged). An ECB may be single or double sided by means of photodegradable or biodegradable exterior netting, depending on the design criteria.

Coconut and jute are a good choice for ECBs that will come into contact with flowing water. They are a thicker and more durable material but are ultimately biodegradable. Straw-coconut blends are also available and may be suitable when an intermediate level of protection is required. If the ECB is intended to protect seeded areas, the density of the fabric should be considered as material that is too dense may not allow sufficient light to penetrate for germination and growth, especially of broad-leaved forbs that often have a hard time growing through dense matting due to their initial leaf structure.

While both biodegradable and geo-textile fabrics provide reasonable short-term (three to five years) soil surface protection, they are not intended for long-term protection. Where long-term protection is necessary, structural-based treatments should be integrated with ECB's or geotextiles to optimize treatment effects over time.

Complete installation guidelines are beyond the scope of this manual, and are readily available from manufacturers of ECB and geotextile products. However, a few installation tips are provided for installation of ECB's along active streambanks:

- ◆ Maintain good fabric-soil contact, and reduce “tenting” by removing rocks, limbs, and other materials greater than five inches in diameter;

- ◆ Install the fabric in a taut manner, and anchor edges of matting in a trench where the greatest stress is expected (i.e., upstream edge, upwind edge, seams between two rolls);
- ◆ Successive rolls of fabric should overlap sufficiently to allow one to two stakes or staples to secure both edges;
- ◆ Though metal staples have long been considered normal for anchoring fabrics, biodegradable wooden stakes are becoming more readily available;
- ◆ Effort should be made to utilize biodegradable materials whenever possible, as over the long term floods can scour restored banks, depositing geotextiles into the stream.

ECBs may be manufactured of 100% plastic mesh, a combination of photodegradable plastic mesh and biodegradable fibers, or 100% biodegradable fibers. While manufactured plastic mesh can provide substantial protection against erosive forces, and photodegradable mesh incorporated with natural fibers can enhance the strength of an ECB, such synthetic materials are known to have deleterious effects on birds, snakes, rodents, aquatic organisms, and other wildlife (Figure 18).



Figure 18. Dead bullsnake in plastic mesh. From AloTerra Restoration Services, LLC. Reprinted with permission.

Because natural meshes such as jute, coir (i.e., coconut) and hemp can provide substantial protection against stressors, are 100% biodegradable, and have significantly less impact on wildlife, they are highly recommended for use in restoration and streambank bioengineering projects.

Hydromulching

Hydromulching is recommended over seeded areas where access to equipment and water is feasible. The use of moderate amounts of hydromulch with tackifier at an application rate of 2500 lb/ac within 24 hours of seed application has been found to be strongly beneficial in the prevention of erosion. Hydromulch application should be done by a professional who is capable of applying the correct amount of product in a manner that will facilitate rather than hinder seed emergence. Avoid applying hydromulch to established vegetation or to the leaves of newly established container or bare-root plantings. When hydromulching is not possible, a variety of dry mulches are available.

Dry Mulches

Dry mulches are loose or baled organic materials that may be applied by hand or blower on top of degraded soils to protect seeded areas and/or reduce soil surface erosion. On steeper slopes, and in areas where flowing water is expected, an appropriate ECB should be used in place of mulch. Depending on the type of material applied, and the steepness of a particular slope, application rates vary widely. A brief list of products, along with basic considerations for application follow:

- ◆ *Wood Shred*: a variety of ground wood, produced in a variety of weights and lengths. A diversity of wood fiber lengths, with a minority of fines (i.e., less than two inches in length), is the key to producing an interlocking mulch structure on the soil surface. Due to the interlocking nature of wood shred, and the heavy nature of this material relative to other materials, it is less likely to blow away in high wind areas.
- ◆ *WoodStraw[®]*: Originally developed by the USFS to be used in high wind areas and to be weed free, WoodStraw[®] is now available by Colorado suppliers. This engineered product may be blown onto a site or hand distributed.
- ◆ *Agricultural Straw (Ag Straw)*. Ag Straw is produced from the culms (i.e., stems) of agricultural products such as wheat, oats, barely, etc. Ag Straw may be blown onto sites or hand applied. While this is often the most economical mulch product available, it is highly susceptible to wind. On flat or otherwise appropriate surfaces, the vulnerability of Ag Straw to wind can be ameliorated by crimping the straw into the soil. Crimping is often not feasible on steeper streambanks, and may be problematic when other structural treatments (i.e., wattles brush mattresses) are installed in the area to be mulched. Due to problems with non-target and invasive species seed found in many agricultural settings, it is imperative that weed-free straw be used. Because Ag Straw labeled as “weed free” can, according to Colorado’s Weed Free Forage Program (Colorado Department of Agriculture), still include invasive species, it is essential the practitioner inspect the agricultural fields and the bales in question before delivery to the work site. Historically, there have been many invasive species introductions through the use of Ag Straw. Hence, where budgets allow WoodStraw[®] or wood shred are better alternatives.
- ◆ *Wood Chips*: Wood chips are uniform and often small (i.e., less than 2 inches) diameter wood products. While they may be effective on flatter slopes, they are vulnerable to downslope movement on steep slopes due to their limited ability to form an interlocking matrix atop the soil surface. As with wood shred and Ag Straw, sourcing off wood chips should ensure the material does not contain unacceptable invasive species.

Weed-free Mulch is Imperative

Due to their adaptive advantages, invasive species have evolved to spread rapidly through disturbed ground. To avoid unintended weed introductions to your site, using weed-free mulch is highly recommended. However, “Weed Free” is not always free of invasive species. The Colorado Department of Agriculture inspects forage and mulch prior to harvest to verify that there are no propagative plant parts of noxious weeds. The use of certified weed free forage and mulch is intended to reduce the spread of noxious species in public lands or other areas forage or mulch is used. According to the state regulations, a variety of invasive species are allowable in certified weed free forage. A few tips to decrease the likelihood of unacceptable invasive species in your mulch:

- ◆ Use engineered products created from a variety of wood processing;
- ◆ Inspect certified weed-free agricultural fields, staging areas, and deliveries prior to accepting straw (stalks of wheat, oats, and other monoculture crops) on site; and
- ◆ Avoid hay, as it is very difficult to produce weed-free.

Straw Wattles

Like erosion matting and mulch, wattles serve to minimize soil erosion on an embankment. *Straw wattles* are manufactured cylindrical rolls of various lengths and diameters intended to reduce soil surface erosion and trap sediments. They are typically made of the same materials as ECBs but are rolled into a cylindrical shape similar to coconut fiber rolls. Unlike coconut rolls, however, straw wattles are not intended for installation below the bankfull elevation. Rather, straw wattles are intended to reduce precipitation-derived erosion on upland hillslopes. They are installed parallel with the contour of a slope, and at a spacing designed to reduce sheetflow and rilling. In order to ensure sufficient ground contact, it is often necessary to dig a shallow one or two inch trench in which to place the wattle. Wattles are secured in place by driving wooden stakes through the center of the wattle every two or three feet. To be effective, a series of wattles should be installed on a hillside, with a greater density in steeper areas (NRCS, 2012). It is important to install these at the highest points of expected erosion in order to prevent surface water from gaining momentum. Over time, they will fill with sediment and degrade. As photodegradable mesh encapsulating a natural fiber wattle can be problematic (i.e., birds and other wildlife get caught in the mesh, or the mesh blows away in small pieces, leaving trash in the landscape), 100% biodegradable wattles are recommended.

5.4 CONCLUDING REMARKS

This chapter provided a variety of plant-based treatments, soil amendment alternatives, and short-term erosion control materials. Given the complexities of environmental conditions (soil quality, precipitation, drought, water-induced bank stressors, etc.) challenging the success of revegetation efforts, it is rarely recommended that a single revegetation treatment be implemented by itself. On the contrary, to facilitate short- and long-term success of plant-based treatments, designers must

consider the synergistic impacts of vegetation, soil amendments, and surface protection acting together in a planned fashion. For more details on revegetation treatments and design considerations for Colorado, the reader is referred to the Native Plan Revegetation Guide for Colorado (Seiple et al., 1998).

6.0 STRUCTURAL-BASED BIOENGINEERING: DESIGN CONSIDERATIONS

Most terrestrial vegetation cannot form roots in continuously saturated soils, leaving soil below the waterline unsuitable for plant establishment. Vegetation plays a significant role in reducing the risk of geotechnical failure and erosion by fluvial forces on banks that are periodically inundated. However, vegetation does little to protect against fluvial erosion below the ordinary high waterline. Employing a combination of structural-based treatments below the waterline with an assortment of appropriate biotechnical treatments above the waterline is likely the best alternative to stabilizing an eroding streambank given the great range of seasonal and inter-annual flow conditions experienced by a stream.

It is important to understand there is a fundamental difference between the design of plant-based treatments and structural-based treatments. Plant-based treatments have an upper limit to the degree of structural support they can impart to a given streambank. While this limits their utility to conditions where smaller increases in bank strength are sufficient to provide bank stability, it also limits the risk that can be incurred from their application. Conversely, structural-based treatments can be designed to withstand substantial stress, but require sound engineering to increase the likelihood of bank stability during high magnitude discharge events. Much of the underlying engineering principles are beyond the scope of this manual. This manual presents basic interpretations of some of the less complex treatments below and refer the readers to the appropriate resources to assess more complex approaches. These interpretations and discussions are accompanied by a strong word of warning that all load-bearing design treatments be assessed by a certified engineer.

The design and restoration of streambanks often requires the application of a combination of treatments. While traditional engineering treatments can be altered or enhanced to provide habitat benefits, a structural-based streambank bioengineering treatment is successful when it results in a relatively static bank. The treatments that would fall in this category rely on rock, manufactured products, or other inert material to result in a fixed condition. Structural measures include tree revetments; log, rootwad and boulder revetments; dormant post plantings; piling revetments with wire or geotextile fencing; piling revetments with slotted fencing; jacks or jack fields; rock riprap; stream jetties; stream barbs; and gabions. Whether used alone or in combination, both structural- and plant-based bioengineering treatments require attention to proper toe protection.

6.1 TOE PROTECTION

Toe protection is essential for many streambank stabilization designs. This is especially true in areas with a high degree of infrastructure at risk due to lateral bank migration, channel widening, or bed degradation that leads to bank failure. These infrastructural features result in constricted flood flows

that increase the potential for lateral bank migration. Structural toe protection is also essential when bank stabilization treatments are applied in areas of naturally high shear stress, such as outside meander bends. Common types of structural toe protection include, but are not limited to: rock riprap, gabions, single or stacked boulders, single logs, root wads, tree revetments, redirective structures, crib-type structures, and engineered log structures, which will be covered in more detail in Chapter 7. Such structural measures have been used extensively and with great success for many years. Of these structural treatments, rock (when designed and constructed correctly) remains one of the most effective protection measures at the toe of an unstable slope. Rock is relatively common in most areas of Colorado and is the material of choice for emergency recovery programs, where quick response and immediate effectiveness are critical.

Due to the high shear stress and long periods of inundation experienced in the toe zone, revegetation treatments are typically not recommended for toe protection. An exception includes willow fascines, which can be effective in smaller streams and in areas where lower shear stress exists.

6.2 LARGE WOODY MATERIAL / DEBRIS

Large woody material (LWM) structures are intended to provide habitat and stabilization, until woody riparian vegetation and stable bank slopes can be established. LWM is susceptible to decay over time unless it is continuously submerged. Their decay rate depends on climatic conditions, wood type, and density. Therefore, structures made entirely or partially of woody materials are not suited for long-term stabilization, unless the wood is preserved by continuous wetting or chemicals. Using wood with higher rot resistance (e.g., black locust, hemlock, cedar) will also reduce decay rates.

Historically, the recruitment of large woody debris (LWD) to fluvial systems occurred through channel migration, wind throw, gathering from flood and debris flows, and the work of beavers. In the recent past, the removal of large woody material from fluvial settings has been a widespread practice. Scientific investigation is highlighting the fact LWD serves a fundamental role in reducing sediment transport and initiating positive morphologic processes that consequently influence the type, quality, and quantity of habitat maintained in the floodplain (Abbe, Embertson, Bruzgul, & Maher, 2014; Wohl, Lane, & Wilcox, 2015; Wohl, 2013). This insight has led to an increase in the incorporation of LWD in river restoration projects (Pettit & Naiman, 2005), and the development of a National Large Wood Manual (Bureau of Reclamation and U.S. Army Engineer Research and Development Center, 2016).

While the authors of this manual support the use of LWM in river restoration, it is important to be aware of the physical, legal, and regulatory implication of its application. The legal setting will vary by jurisdiction, but the physical limits, for all practical purposes, are universal. Some basic design considerations are covered below.

6.3 FACTOR OF SAFETY

In its simplest form, determination of the stability of a structural-based treatment is based on a calculation of a *Factor of Safety* (FS), which varies according to the ratio between the weight of the materials relative to the lift and buoyancy forces of the material-water interaction. The content presented here is based on the work of D'Aoust and Millar (2000), and the reader is referred to this work for further information. It is important to reiterate that this design approach is intended to estimate the stability of a single log with a boulder anchor, and is not intended for the assessment of more complex structures. The FS must be assessed from two perspectives:

1. *Buoyancy*: Can the treatment remain stable relative to its own buoyancy; and
2. *Sliding*: Can the treatment remain stable when the anticipated lift forces created by the moving water are exerted upon it?

These FS parameters can be calculated for a single log with a large boulder anchor and without an attached root wad via the following equations. If either of these FS parameters results in a value less than one, the treatment can be considered unstable for the design conditions.



Large Woody Structure Stability Analysis Tool

The Large Woody Structure Stability Analysis Tool developed by Ellen Wohl and Brian Bledsoe provides a comprehensive and flexible Microsoft Excel spreadsheet which can be used to efficiently evaluate and optimize design options, such as the size and species of wood, structure configurations, and anchor requirements (Bledsoe & Wohl, 2016). The companion paper (Rafferty, 2013) summarizes the design rationale, methodologies, procedure, limitations, and example applications to illustrate how the tool can be used to design stable structures.

6.4 NON-WOODY TOE STRUCTURES

A great variety of commercial and locally constructed non-woody structures may also be used to protect the toe of a streambank. Plant Rolls and Wraps are two common examples. While rolls and wraps are not ideally suited to larger stream systems or areas where predicted shear stress is high, they perform successfully in smaller streams, backwater areas of larger streams, and in a multitude of other settings. Commercial products that integrate wetland plugs and similar living elements are becoming more common in the marketplace, though their acquisition, staging, and installation costs may be a limiting factor for many projects.

Plant Rolls

Plant rolls are nine- to 12-inch diameter cylindrical structures of varying length, and are usually made of coconut fiber or burlap. Plant rolls are generally constructed on site by laying fabric across the

ground, and then filling with a layer of soil and grass plugs that protrude from the seam or from pre-cut holes in the matting. They may also include willows cuttings, placed in the roll such that cuttings are in contact with the moist trench in which the roll is placed. Rolls can provide immediate protection from water erosion due to their weight and bulk, and over time, will root into the surrounding soil. Often, they are effective in areas of fluctuating water level where seeds would be washed away. The ends and seams of rolls are secured with untreated twine or hog rings. The rolls are placed into trenches deep and wide enough to contain the roll, parallel to the streambank, and are anchored with dead stakes.

Wraps

Wraps are similar to plant rolls except they are larger and usually contain more soil. As such, they are installed in the excavated trench by placing the fabric inside first with edges lying outside equally on each side. The fabric is then filled with soil to near the top as the fabric sides are brought together. Containerized plants, field transplants, or willow cuttings can be placed in the top. Finally, the ends are brought over one another and secured with ties or hog rings, and then anchored.

6.5 CONCLUDING REMARKS

The material covered in this chapter, when considered together with the technical considerations of previous chapters, is intended to provide the designer with a full range of technical considerations involved in designing and implementing structural-based bioengineering treatments. With better understanding of design considerations, future bioengineering projects will have an improved chance of yielding successful results. Such success will in turn make bioengineering practices more acceptable in stream restoration, road embankment protection, and other similar activities in Colorado floodplains.

7.0 STRUCTURAL-BASED BIOENGINEERING: TREATMENTS

The following structural-based treatments are provided to better understand the integrated nature of plant- and structural-based treatments, and highlights the importance of mitigating toe stresses. Following appropriate toe stabilization measures, bank protection measures have a greater chance of succeeding. For more comprehensive information on bioengineering treatments, the reader should refer to several of the excellent references at the end of this manual.

7.1 BASIC TREE STRUCTURES

Single Log

Single logs are versatile tools in bioengineering. Single logs can be anchored into a hillslope to increase stability or provide surface erosion protection. Similar to all structural treatments intended to impart structural stability to an embankment, the physical properties of the log must be assessed by a certified engineer to determine their ability to bare the intended load. Similarly, a log intended to remain in place at the surface must be assessed for stability relative to the hydraulic and buoyant forces anticipated in its proposed location during the design discharge. It is important to understand that when conditions greater than the design discharge occur, it is possible that the log will become unstable. In Chapter 6, a calculation of the stability of a single log with a boulder anchor relative to the lift and buoyancy forces applied by flowing water is presented. In the sections below, the application of several of the most common anchoring treatments and multi-log structures are presented.

Root Wads

Root Wads can either be used independently of the tree from which they originated, or as an intact portion of that tree to reduce bank scour. Like all woody structures, root wads provide organic inputs into the stream, supporting important stream insect guilds, creating shelter for fish, and affording other biological benefits. If used independent of the remaining tree, the root wad is often applied in combination with an anchoring mechanism. Large boulders are often used as the anchor for a root wad, but this role can be filled by other anchor types or by embedding the trunk of the tree adequately into the embankment, with the mass of backfill acting as the anchor (Figure 19).

CROSS SECTION:

Not to Scale; Mature, leafed-out condition depicted

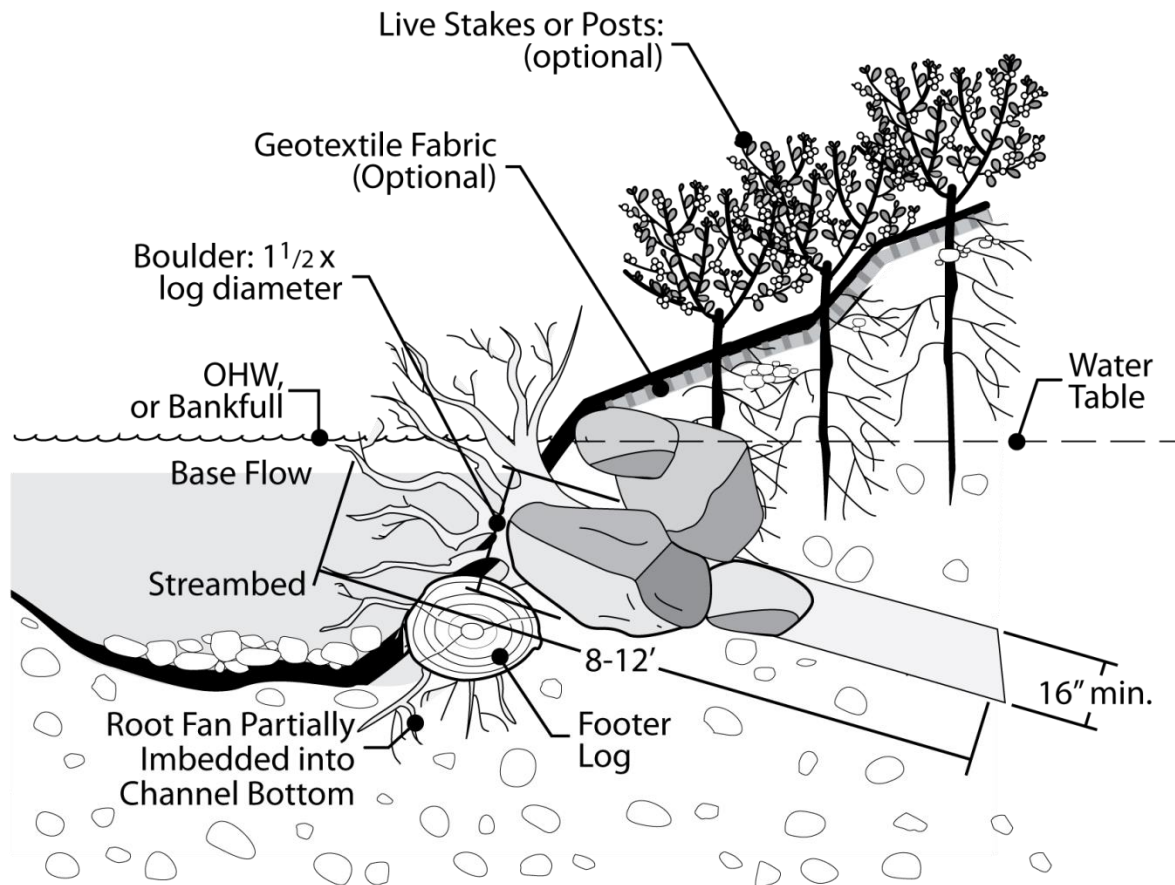

Figure 19. Log Anchor / Root Wad Revetment (Adapted with permission from Eubanks & Meadows, 2002).

Tree Revetment

Tree Revetments (Figure 20) consist of anchored, dead trees placed along the shoreline or riverbank to dissipate flow or wave generated energy, thereby reducing erosion. Although technically not a structural treatment, tree revetments have been included in this section based on the building material used and the installation methods. The logs comprising the breakwater structure can either consist of the main trunk only or be applied with their branches intact. Trunk-only logs are used when greater energy dissipation capacity is needed and when erosion control will be necessary for a greater duration of time. Logs with the branches intact are usually applied when relatively lower erosive forces are anticipated and the need for erosion protection is of short duration.

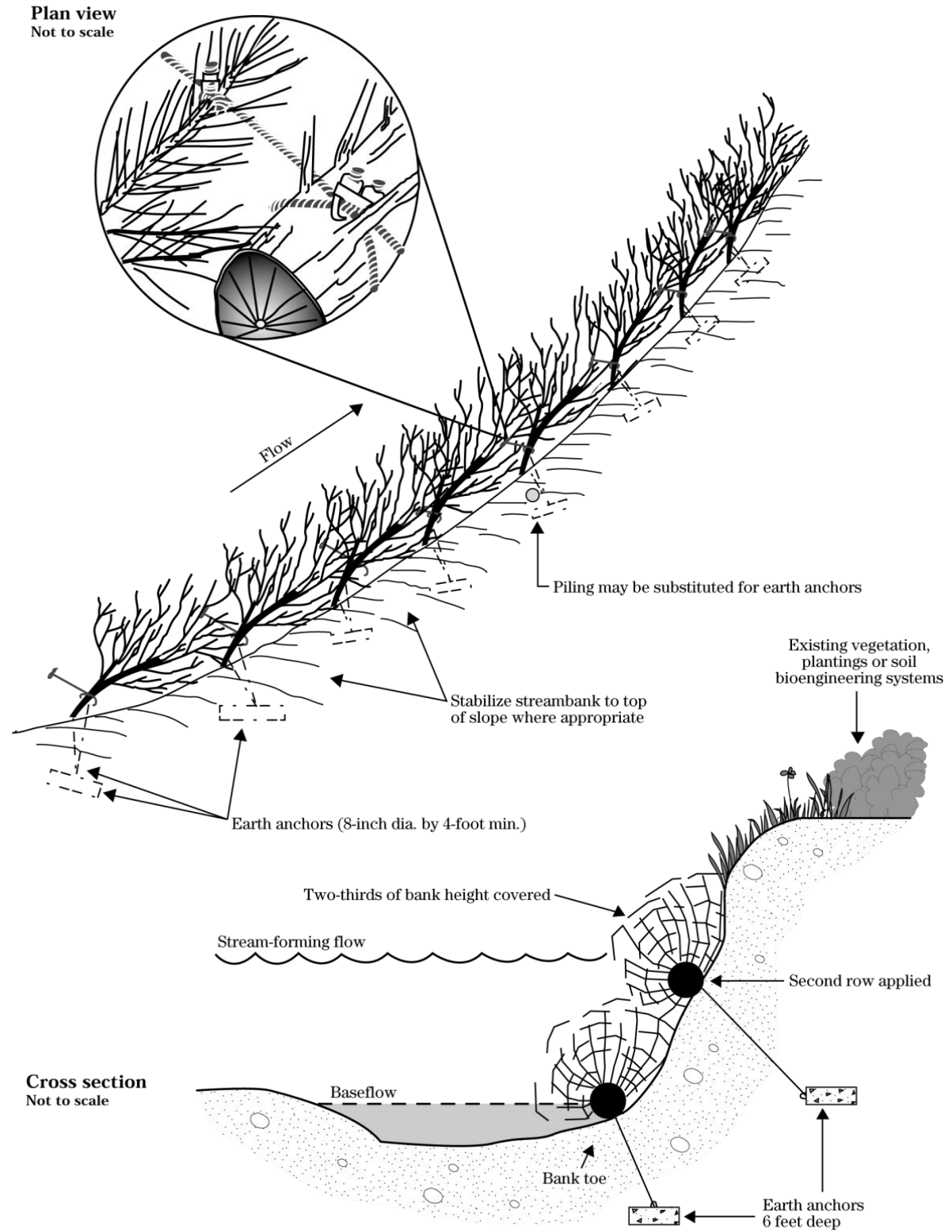

Figure 20. Tree Revetment (NRCS, 1996).

7.2 INCORPORATION OF ANCHORS

Anchors increase the bond strength between a structure and the material it is mounted on in one of two ways: (1) acting as ballast by adding mass to the material, as in the case of the boulder anchor, or (2) by bonding the treatment to the adjacent embankment, as is the case with a soil anchor. Sometimes these types of anchor mechanism are combined, as is the case of a buried dead weight. In Figure 19, a boulder is used as an anchor. The bond between the anchor can also be formed via a rock bolt and cables.

With the advent of the use of large wood in restoration projects over the past few decades, a new treatment in which the logs themselves serve as anchors has become popular. In such treatments, a long log is incorporated into the treatment, either as part of the main structure or in addition to it. One end is flush with the adjacent members, while the protruding end is embedded within the bank. Depending on the intended function of the treatment either the rooted or non-rooted end can be embedded within the bank. If greater erosion protection is desired, the root wad can be placed in the side of the treatment that experiences the flow of the main channel. Conversely if greater stability is required, the root ball can be buried within the embankment, creating a more substantial anchor.

NRCS's NEH Part 654 Technical Supplement 14E (NRCS, 2007) presents three of the more commonly used anchoring methods: driven soil anchors, screw-in soil anchors, and cabling to boulders or bedrock. The supplement also covers a method for estimating the pullout capacity required of the anchor and another method for connecting of the anchor to a LWM structure. Selecting the anchoring method and sizing the anchor require information about the expected streamflows and soil characteristics.

Soil anchors are another method of anchoring structures. Like other anchors, soil anchors principally act in two methods. The first places an object into an earth material in such a way as to make it difficult to remove. An example of this is the *duckbill anchor*. Duckbill anchors are shaped such that they travel into a drilled hole parallel to the hole axis. Once installed, the anchors are placed under tension. The spoon shape of the blade causes it to dig into the side of the hole and rotate until it is perpendicular to the hole axis. The hole is subsequently back filled with material. The strength of the anchor is thus dependent upon the ability of the anchor to remain within the earth material, and the ability of the earth material to resist the force applied to it via the treatment and the anchor. The second type of soil anchor is known as a dead weight anchor, which creates added ballast via a combination of additional mass and added embedding within the earth material. These anchors often take the form of buried concrete blocks. In addition to the added ballast from the mass of the concrete, the mass of the earth material in which it is embedded serves to strengthen the anchor.

7.3 REDIRECTIVE STRUCTURES

Attached to the bank, *redirective structures* provide intermittent (discontinuous) bank protection by redirecting stream energy away from the bank. These structures usually provide higher levels of physical diversity and, therefore, higher levels of habitat quality than continuous methods (Shields, Cooper, & Testa, 1995). Redirective treatments can increase backwater areas, increase edge or shoreline length, and can result in diversity and complexity of depth, velocity (both vertical and horizontal), and substrate and flow patterns. Examples of indirect, usually discontinuous, treatments that redirect the flow and energy of the river or stream away from the area of the eroding bank include *large woody debris* structures (Shields, Morin, & Cooper, 2004; Abbe & Brooks, 2011), log or *rock vanes* (Rosgen, 2001, August), *J-hook vanes* (Rosgen, 2001, August), *rootwad revetments*, *bendway weirs*, and *spurs* or *spur dikes*.

When discontinuous-type, bank attached, redirective protection methods are specified, allowances must be made for erosion between the structures (also called *bank scalloping*), which leads to an uneven bankline. Bioengineered treatments, such as live brush layering, vegetated mechanically stabilized earth (VMSE), and live siltation can often be used to reduce or eliminate bank scalloping. Redirective treatments generally have more habitat value than resistive (i.e. continuous bank lining) treatments (Shields et al., 1995).

Large Woody Debris Structures

Properly installed, *Large Woody Debris Structures* (LWDS) can be used to amplify dominant geomorphic processes, perhaps emulating natural geomorphic and ecological recovery (Shields, Knight, & Cooper, 2000; Downs & Simon, 2001). One example of a LWDS is the *Engineered Log Jam* (ELJ), depicted in Figure 21. ELJs serve to add stability to a bank by bearing the forces applied to them by both flowing water and the weight of the adjacent soil (D'Aoust & Millar, 2000). The application of such treatments requires a quantitative assessment by a certified engineer to ensure that it is designed to have the highest likelihood of withstanding the turbulent and gravitational forces applied to it. Design guidance for the use of large woody debris/material for habitat and bank protection can be found in NRCS's NEH Part 654 Technical Supplement 14J (NRCS, 2007).

LWDS may be designed to resist displacement by interlocking, keying-in to banks, anchoring, and by trapping sediment and organic matter input both from adjacent mass wasting and material transported into the reach from upstream. Initial success of LWDS depends upon their ability to resist flotation. The main body of the LWDS should provide stem density great enough to reduce velocities and turbulence adjacent to the bank toe, encouraging sediment deposition and retention. Proposed design criteria for LWDS are outlined by Shields et al. (2004), while Abbe and Brooks (2011) provide detailed guidance on the structural design, force balance analysis, and risk assessment for ELJs.

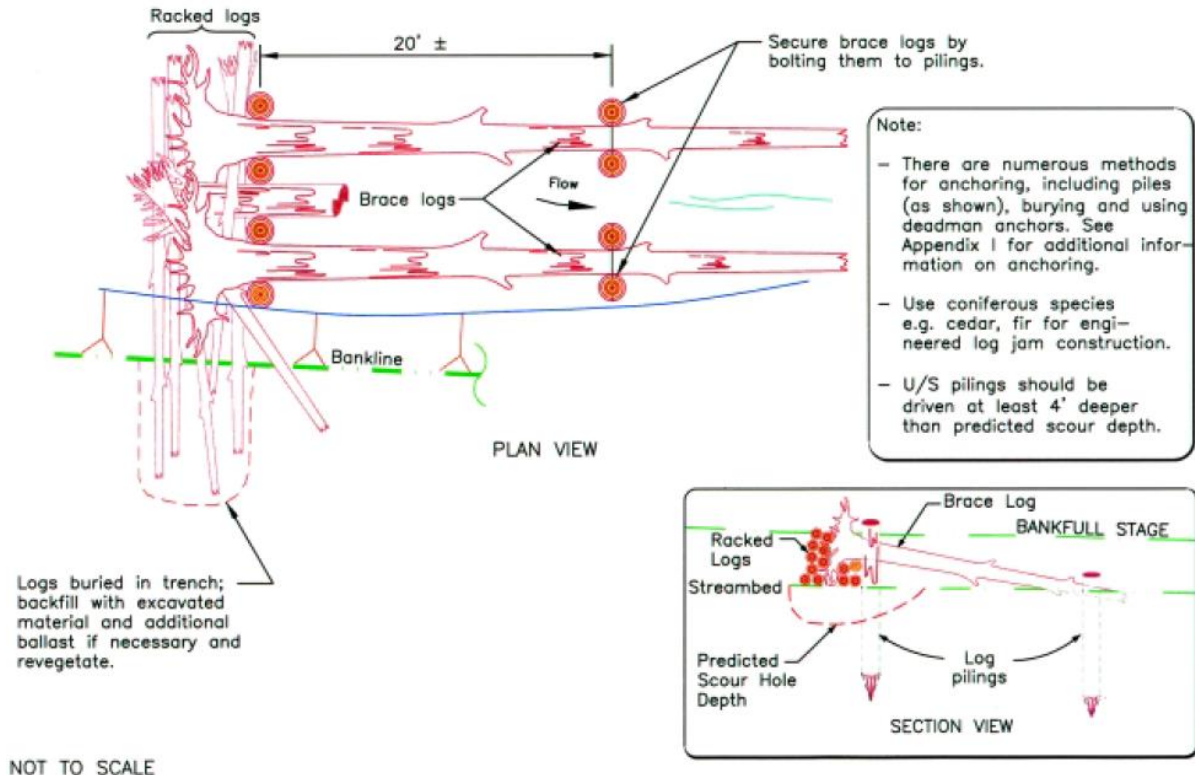

Figure 21: Engineered Log Jam with logs used as anchors (Cramer, 2012).

Rock, Log, and J-Hook Vanes

Vanes are linear structures extending from the streambank into the stream channel in an upstream direction. Essentially, vanes mimic the effect of a tree partially falling into the stream. Vanes are usually placed where erosion is occurring along the toe of the slope. The purpose of vanes is to reduce erosion along the streambank by redirecting the stream flow toward the center of the stream. In addition, they tend to create scour pools on the downstream side.

Vanes can be made of rock (Figure 22) or log (Figure 23). They grade down from the bankfull elevation at the streambank to the channel invert at their terminus in the stream. Vanes generally extend out from the streambank 1/3 of the bankfull width and are angled upstream from the bank at a 20 to 30 degree angle. They should be carefully located and installed so as not to produce additional erosion on the upstream side where they meet the bank (i.e., *eddy scour*) or allow flows to outflank them, exacerbating existing bank erosion problems. The only difference between the *log vane* and the *rock vane* is the material used.

Rock vanes are constructed by first excavating a trench for the footer stones. The footer stones are then placed in the trench so that there is a gap between them equal to 1/3 of the stone diameter. This gap will allow the vane stones to interlock with the footer stones. The vane stones should be placed on top of the footer stones so they are staggered over two adjacent footer stones and skewed slightly upstream of the footer stones. As the vane is built out and slopes down from the bank, footer stones

will become unnecessary when the vane stones can be placed in the trench and extend up to achieve the desired elevation.

The J-hook vane (Figure 24) is similar to a rock vane with the exception that it curls in the shape of a “J” at the terminus. The curved portion serves to enhance downstream scour pool formation.

Section & Plan Views Adapted
From Rosgen (1999)

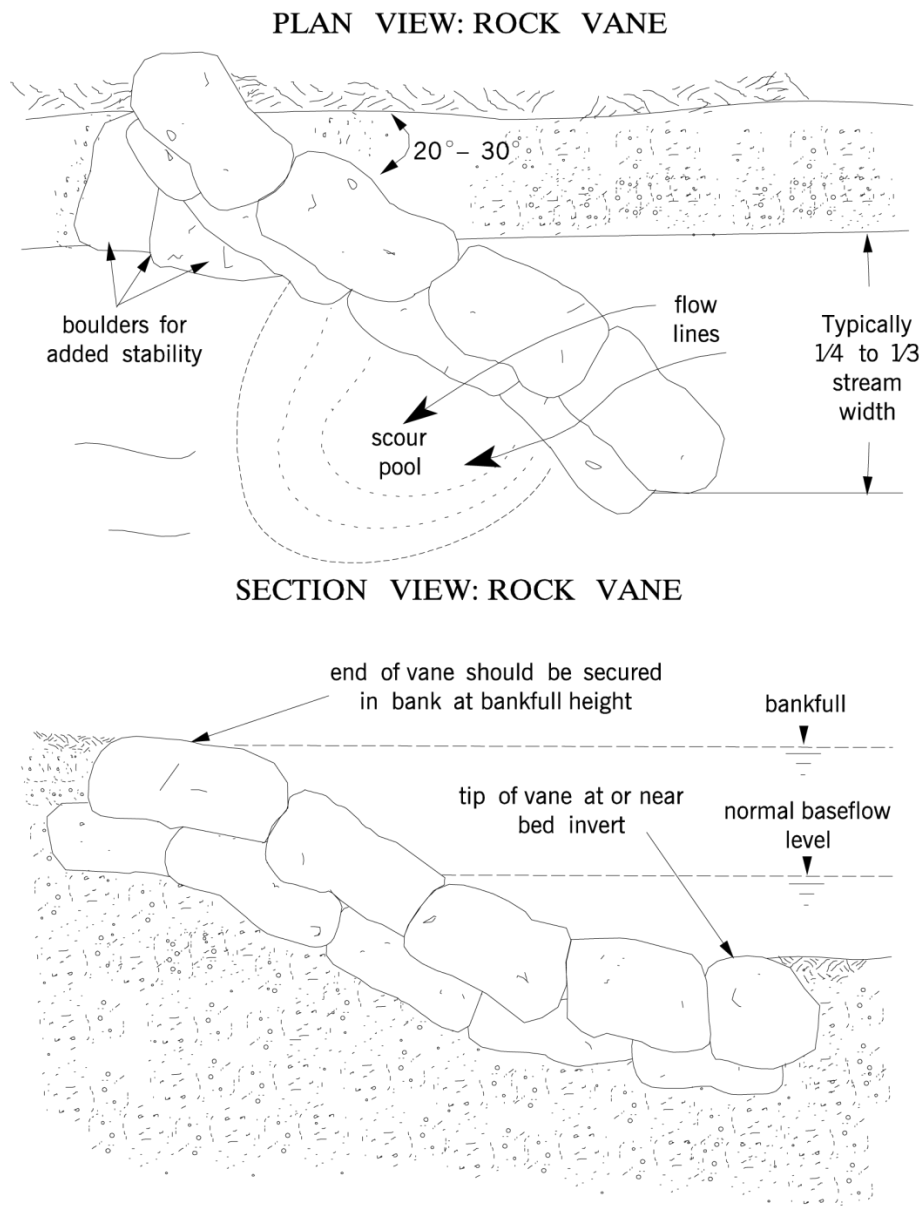
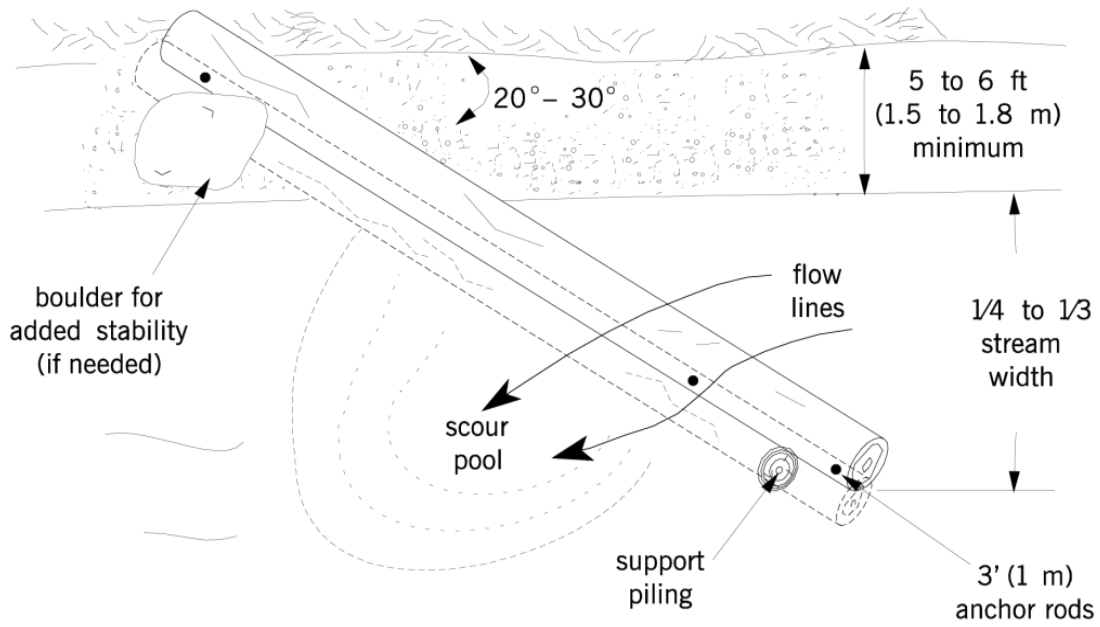

Figure 22. Plan and profile view of a rock vane (Maryland Department of Environment [MDE], 2000).

PLAN VIEW: LOG VANE



SECTION VIEW: LOG VANE

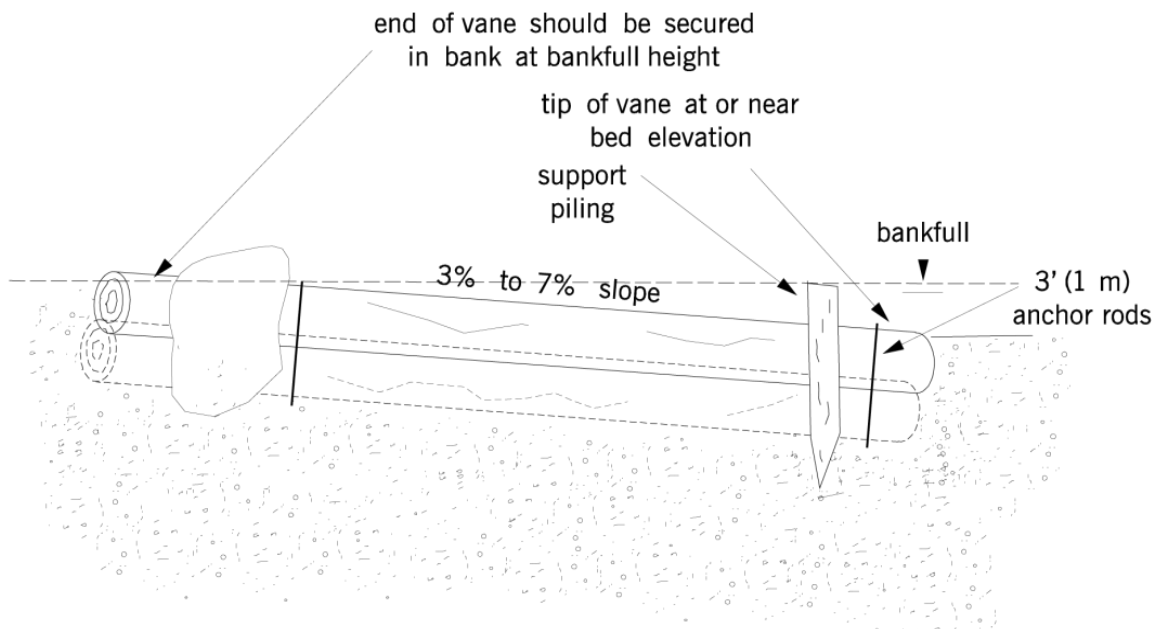
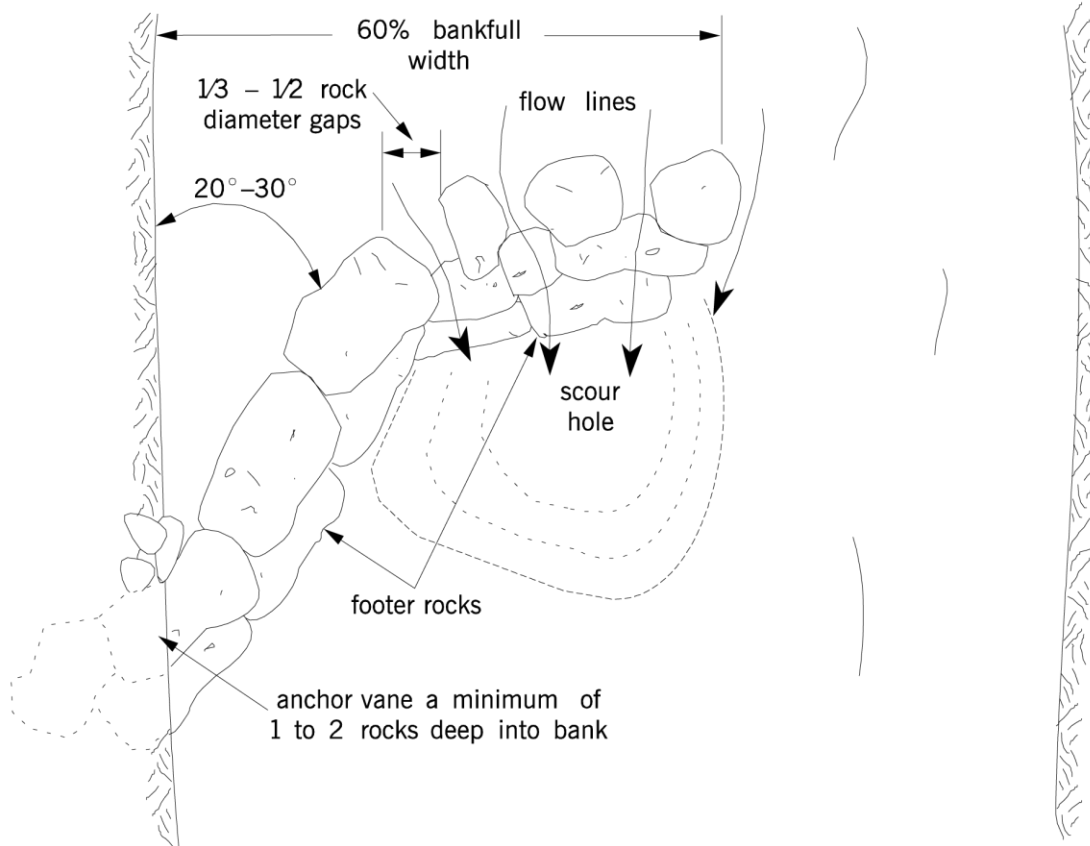

Figure 23. Plan and profile view of a log vane (MDE, 2000).

Section & Plan Views Adapted
From Rosgen (1999)

PLAN VIEW: J-HOOK VANE



SECTION VIEW: J-HOOK VANE

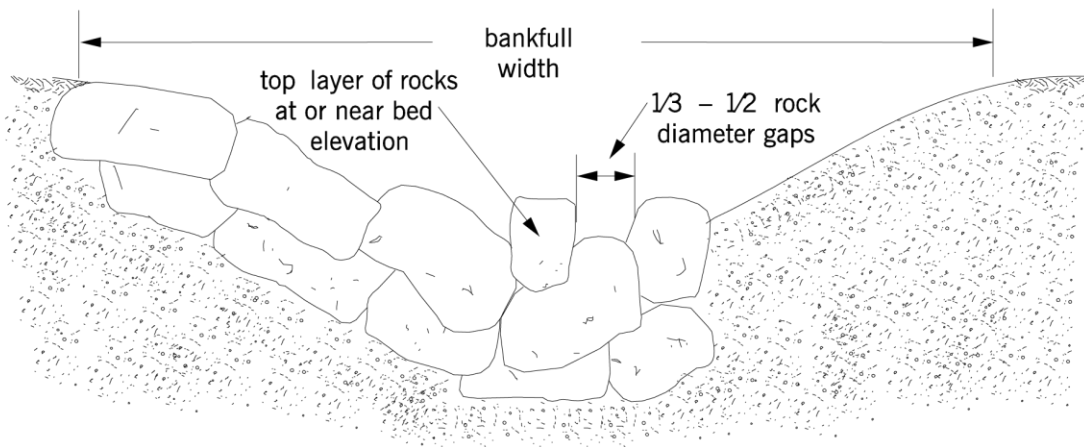

Figure 24. Plan and profile view of a J-hook vane (MDE, 2000).

8.0 INTEGRATION OF PLANT-BASED AND STRUCTURAL-BASED BIOENGINEERING

This chapter presents details of designs combining physical and vegetative materials to form well-integrated bioengineering treatments. Remembering the structural- and plant-based design considerations presented in previous chapters, the authors intend this chapter to underscore the synergistic effect of combining such treatments into a single structure. When designed and implemented correctly, such integrated structures have a tremendous ability to stabilize banks and enhance riparian habitat in a manner that addresses the multiple objectives and aesthetics a healthy riparian corridor provides. The treatments presented herein were selected due to their suitability to Colorado riparian systems, their general acceptance for streambank protection, and the availability of standard construction materials used.

8.1 INTRODUCTION

The integration of plant-based and structural-based treatments produces a higher degree of bank protection than plant-based or structural-based treatments alone, while addressing multiple ecological and cultural values. However, due to the window of risk immediately following installation of plant-based treatments, structural-based treatments must be designed to function independently of any plant-based treatments in which they are integrated. Finally, while adequate toe slope protection is important for many bank stabilization projects, such toe protection is often an essential component of the majority of projects integrating plant-based and structural-based treatments.

8.2 VEGETATED RIPRAP

Continuous and resistive bank protection measures, such as riprap and longitudinal rock toes, are primarily used to armor the bank zones of outside meander bends or areas with impinging flows. These continuous and concentrated high velocity areas will generally result in reduced aquatic habitat. It has been widely documented that resistive treatments such as riprap provide minimal riparian or aquatic habitat benefits (Shields et al., 1995).

The negative environmental consequences of riprap can be reduced by minimizing the height of the rock revetment up the bank and/or integrating plant-based treatments such as vegetated riprap, vegetated soil lifts, joint planting, brush layering, pole planting, and other treatments described in this manual. Collectively, the practice of installing live stakes and/or poles between the joints or open spaces of riprap or other rigid structural materials (Figure 25) is referred to as *joint planting* (Eubanks & Meadows, 2002). When employing joint planting, appropriate bank angle is critical to short- and long-term stability. In tight corridors where a shallow bank angle is not possible, joint planting may still be effective given adequate toe protection.

CROSS SECTION:

Not to Scale; Mature, leafed-out condition depicted

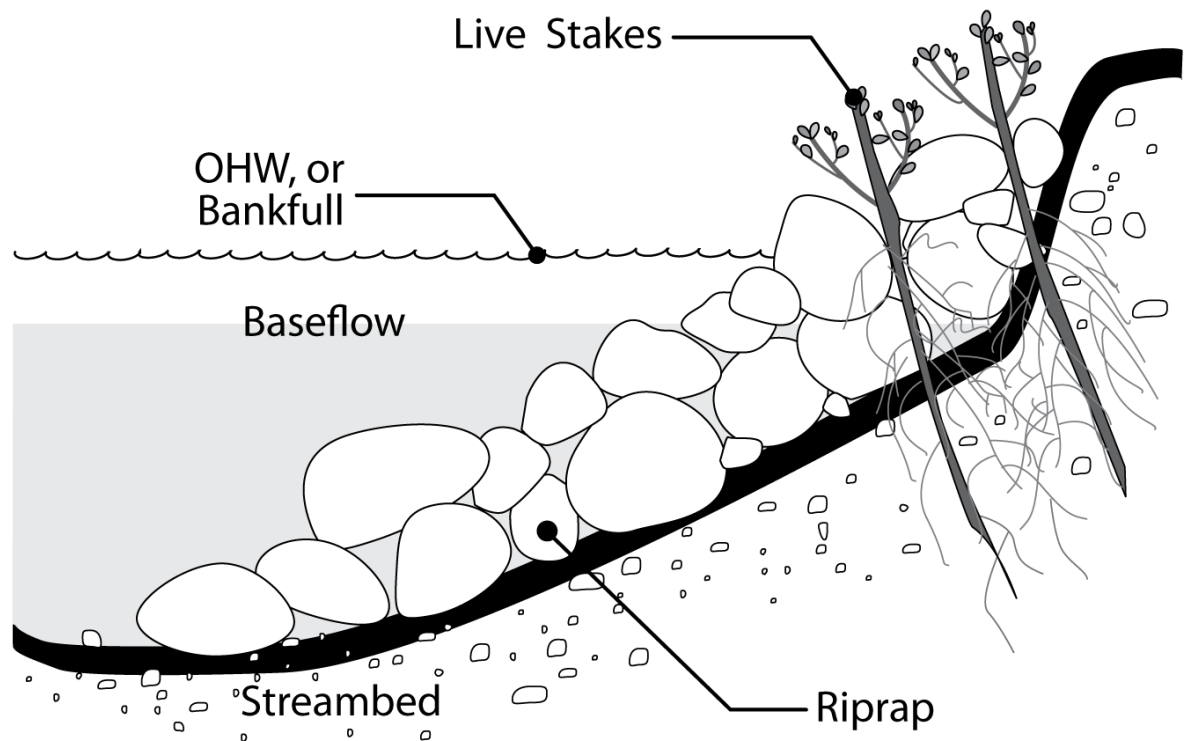

Figure 25: Joint Planting / Vegetated Riprap (Adapted with permission from Eubanks & Meadows, 2002).

Combining riprap with deep-rooted vegetative planting (e.g., brush layering and pole planting) is also appropriate for banks with geotechnical problems. Roots, stems, and branches provide additional tensile strength to the soil and reductions in shear stress near the surface of the riprap. It is common to provide structural-based and integrated plant-structural treatments as high as the 25-year flood elevation of a bank, relying solely upon plant-based treatments above that elevation. The design team should clarify the design discharge for a project with project planners prior to any bioengineering project, as it will have significant influence on the suitability of all treatments in this manual.

When correctly designed and installed, joint planting, vegetated riprap and other streambank bioengineering treatments which integrate plant-based treatments and structural-based treatments offer an opportunity for the designer to attain the immediate and long-term protection afforded by riprap with the habitat benefits inherent to a healthy riparian buffer. The riprap will resist hydraulic forces, while roots and buried stems increase geotechnical stability and reduce soil erosion and *pip*ing (i.e., pore failure from behind the structures), and increase *pullout resistance* (McCullah & Gray, 2005). The pullout resistance of a root is the measured resistance of the root structure to being removed from the ground through pulling. Pullout resistance is likely to be slightly less than the measured tensile strength of the root, which is the root's resistance to breaking as measured in the

laboratory. Four methods for constructing vegetated riprap have demonstrated effectiveness (Lagasse, Clopper, Zevenbergen, & Ruff, 2006):

- ◆ Vegetated riprap with willow bundles (Figure 26);
- ◆ Vegetated riprap with bent poles (Figure 27);
- ◆ Vegetated riprap with brush layering and pole planting (Figure 28); and
- ◆ Vegetated riprap with soil cover, grass, and ground cover.

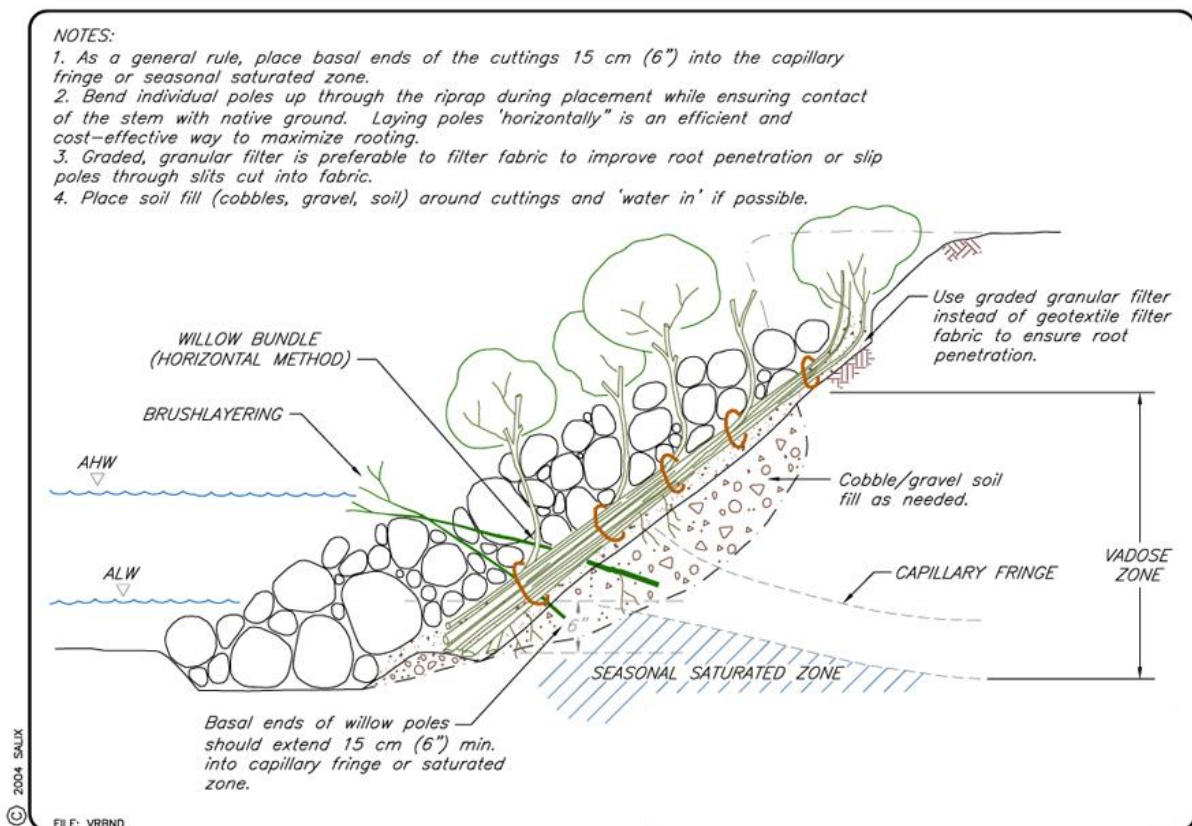

Figure 26. Vegetated riprap with willow bundles (Reprinted with permission from McCullah & Gray, 2005).

Selection criteria and design guidelines for vegetated riprap treatments can be found in McCullah and Gray (2005), which also includes an interactive software program (on CD-ROM) for the selection system entitled "Greenbank" (© Salix Applied Earthcare). Lagasse et al. (2006) also provides design guidance, benefits, limitations and potential causes for failure of vegetated riprap.

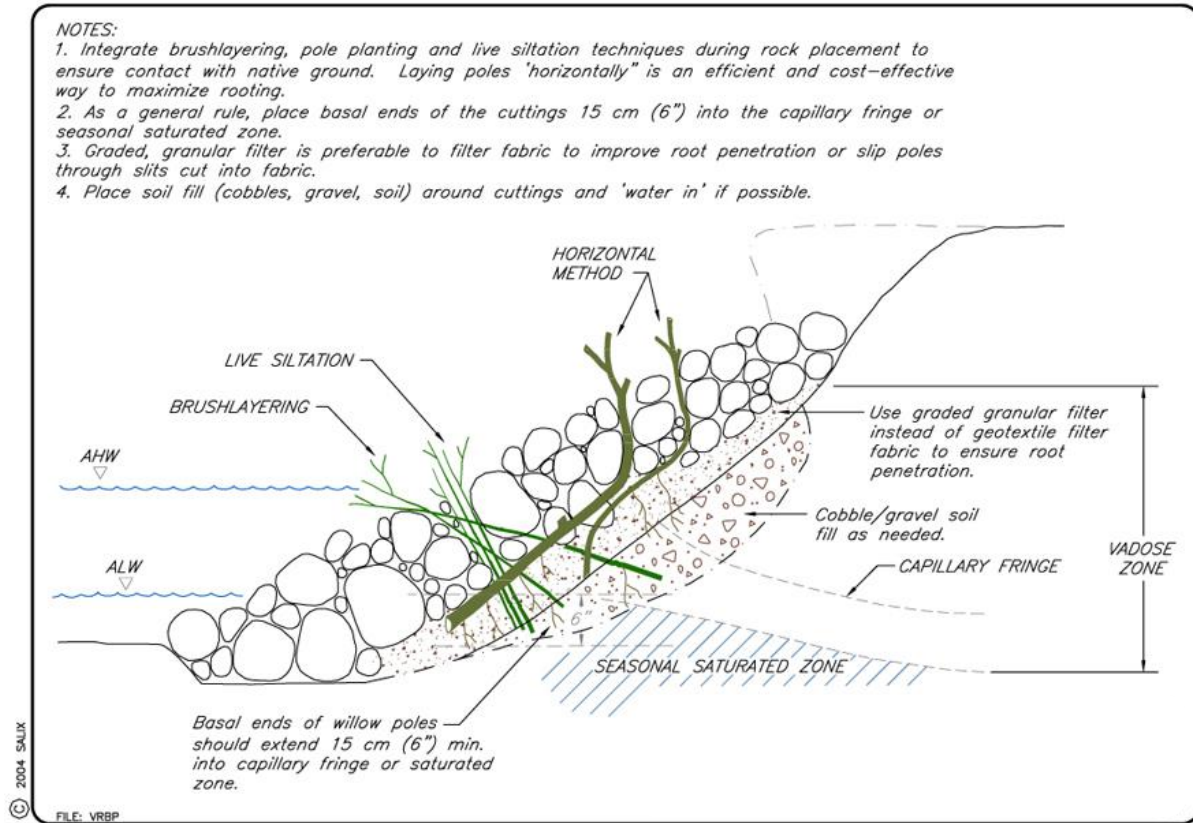

Figure 27. Vegetated riprap with bent poles (Reprinted with permission from McCullah & Gray, 2005).

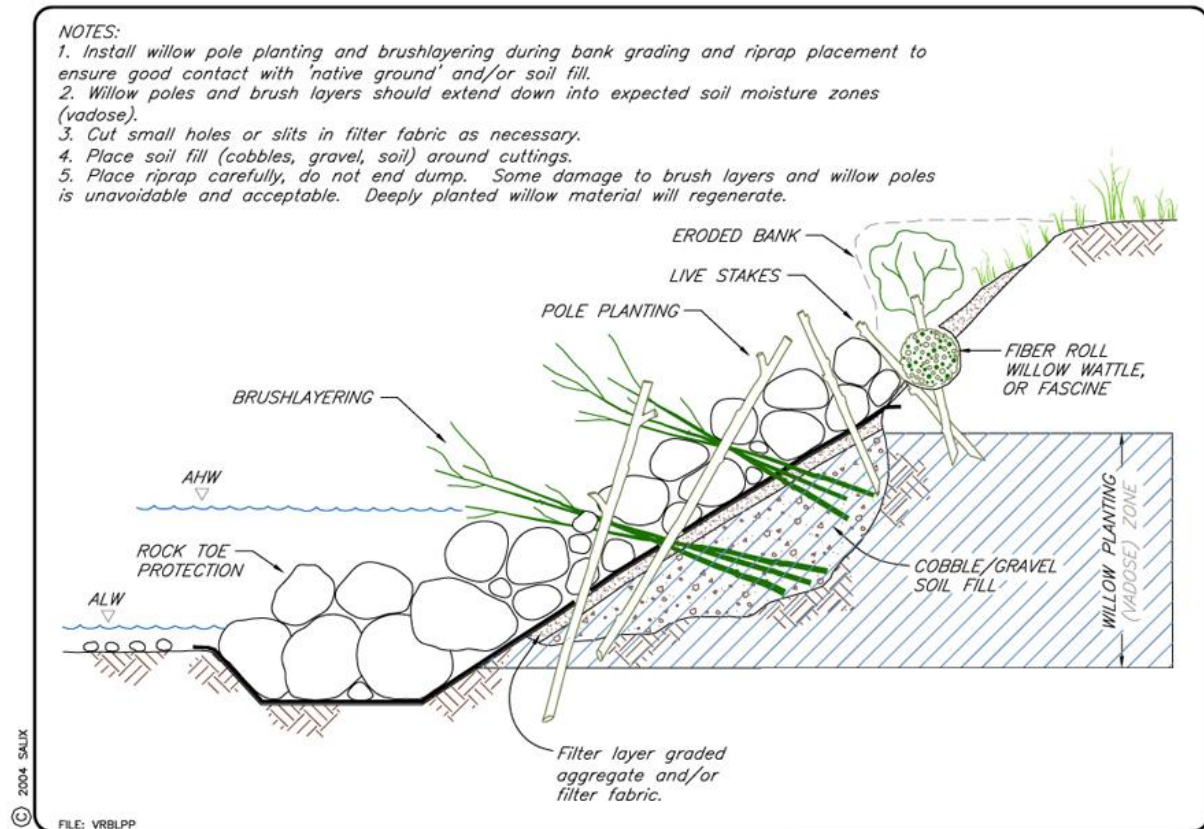

Figure 28. Vegetated riprap with brush layering and pole planting (Reprinted with permission from McCullah & Gray 2005).

8.3 VEGETATED CRIB STRUCTURES

Vegetated Crib Structures (i.e., crib walls) are similar to Engineered Log Jams in that they are organized stacks of wood. Unlike ELJs, Crib Structures are intended to remain in contact with the adjacent bank material, thereby protecting it from erosion while supporting the bank, while ELJs are designed to interact more independently with flow.

Similar to log cabin construction, logs or timbers are organized in a four-walled shape to create an internal chamber that is filled with rock, soil, and plant materials (Figure 29). Vegetated crib structures serve both as erosion protection and structural bank stabilization. Crib structures can be used to stabilize banks equal to their height, and often serve as toe protection. A crib structure's ability to provide required stability relative to the forces of lift, buoyancy, and the gravitational forces from the adjacent embankment must be assessed by a certified engineer. While its ability to resist erosion is provided by the logs that compose the structure, a substantial degree of surficial erosion resistance can be added by incorporating plant based bioengineering treatments (Hoag & Fripp, 2005).

Cross section
Not to scale

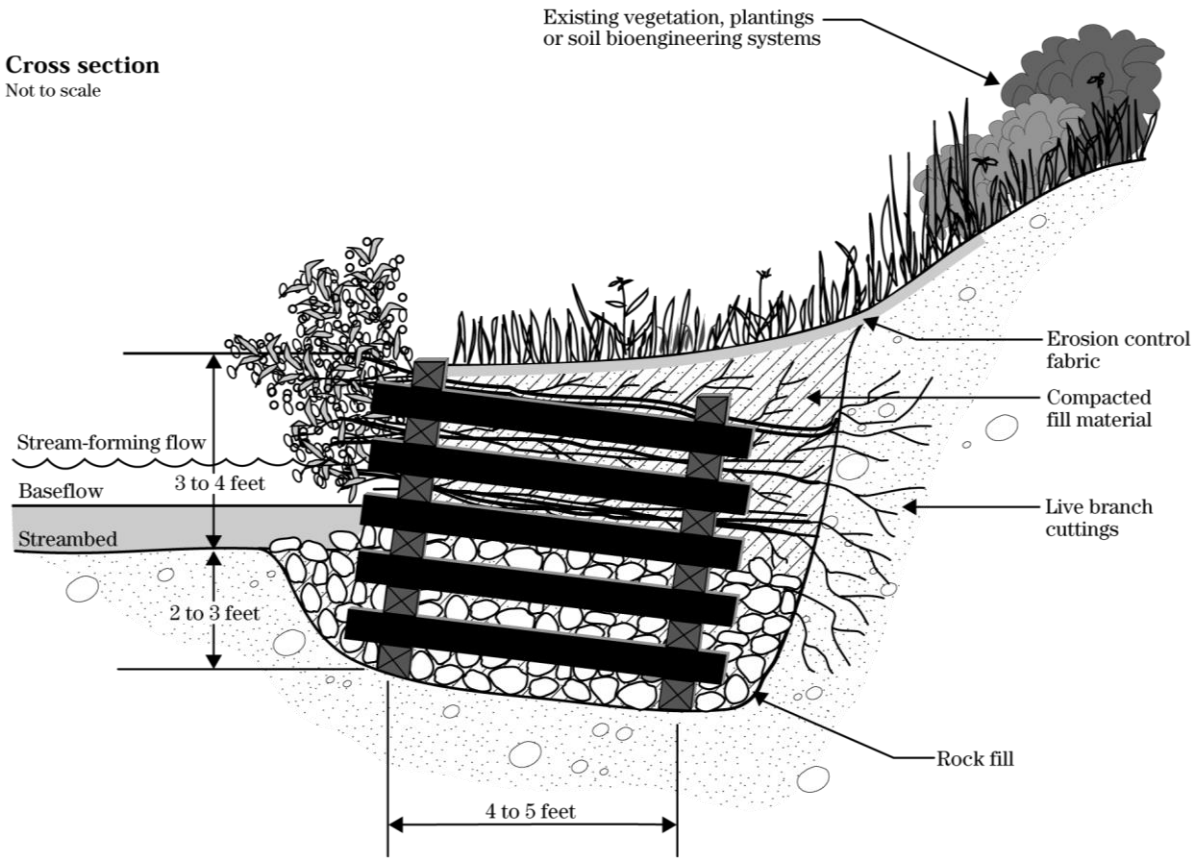

Note:
Rooted/leafed condition of the living
plant material is not representative of
the time of installation.

Figure 29. Crib Structure (NRCS, 1996).

Given the robust nature of crib structures, they can be applied in those portions of a channel in which a greater level of structural stability is required. The internal portion of the box formed by the crib structure may be filled with a combination of inert and biological fill to facilitate stability and serve as a rooting medium. Inert materials used for this purpose include a range of rock sizes, while the biological material consists of live poles, branch cuttings, container stock, bare-root stock, and/or seed. The plant-based treatments should be designed to have their branches protruding out of the side of the structure that is intended to be exposed to flowing water, while their roots should be oriented such that they will grow into the adjacent bank (Figure 29). Due to the vertical nature of a crib structure, they often span from below the bed of the stream to above the bankfull discharge water surface elevation. Thus, the plant materials must be oriented such that plants tolerant of frequent inundation are located immediately above the toe zone and more drought-resistant plants are located near the top of the structure. Rock fill may be added only to an elevation within the structure necessary to ensure adequate mass of the structure; biological soil and plant materials should be focused at the bank and higher elevations.

Crib structures can also be enhanced through the use of anchors, as described in the previous chapter. Additionally, root wads can be incorporated into the design of a crib structure such that they

either decrease erosion potential, by dissipating energy where they protrude out from the structure, or by performing like a log anchor when buried within the embankment. Additionally, crib structures can consist of a series of interconnected box structures rather than being limited to a single box-like structure.

8.4 VEGETATED SOIL LIFTS

Vegetated soil lifts (Figure 30 and Figure 31), also known as *vegetated mechanically stabilized earth* (VMSE), are lifts of soil covered with erosion control fabric (geotextile) and integrated with plant-based treatments to stabilize bank zones immediately above the toe. The fabric-wrapped soil lifts are also known as *fabric encapsulated soil* (FES). The erosion control fabric is secured by tucking it into the slope. Where significant toe erosion or toe scour is expected, the toe of the bank is usually stabilized by geotextile wrapped rock lifts, riprap, or some other form of structural toe protection. Live cuttings are placed between the lifts immediately above the toe, where access to the water table is possible. Over time, an increasingly dense root structure is established to bind the soil within and behind the lifts.

Advantages and Disadvantages:

- ◆ Vegetated soil lifts can be used where the bank cannot be re-graded to a shallower slope;
- ◆ Vegetated soil lifts can be used where a bank has severely eroded;
- ◆ Similar to crib structures, an adequate amount of soil and rock must be available to fill the void between the bank and the lifts; and
- ◆ Rapid vegetation growth is promoted from the live cuttings, which decreases flow velocities and shear stresses along the bank during high water stages.

CROSS SECTION:

Not to Scale; Mature, leafed-out condition depicted

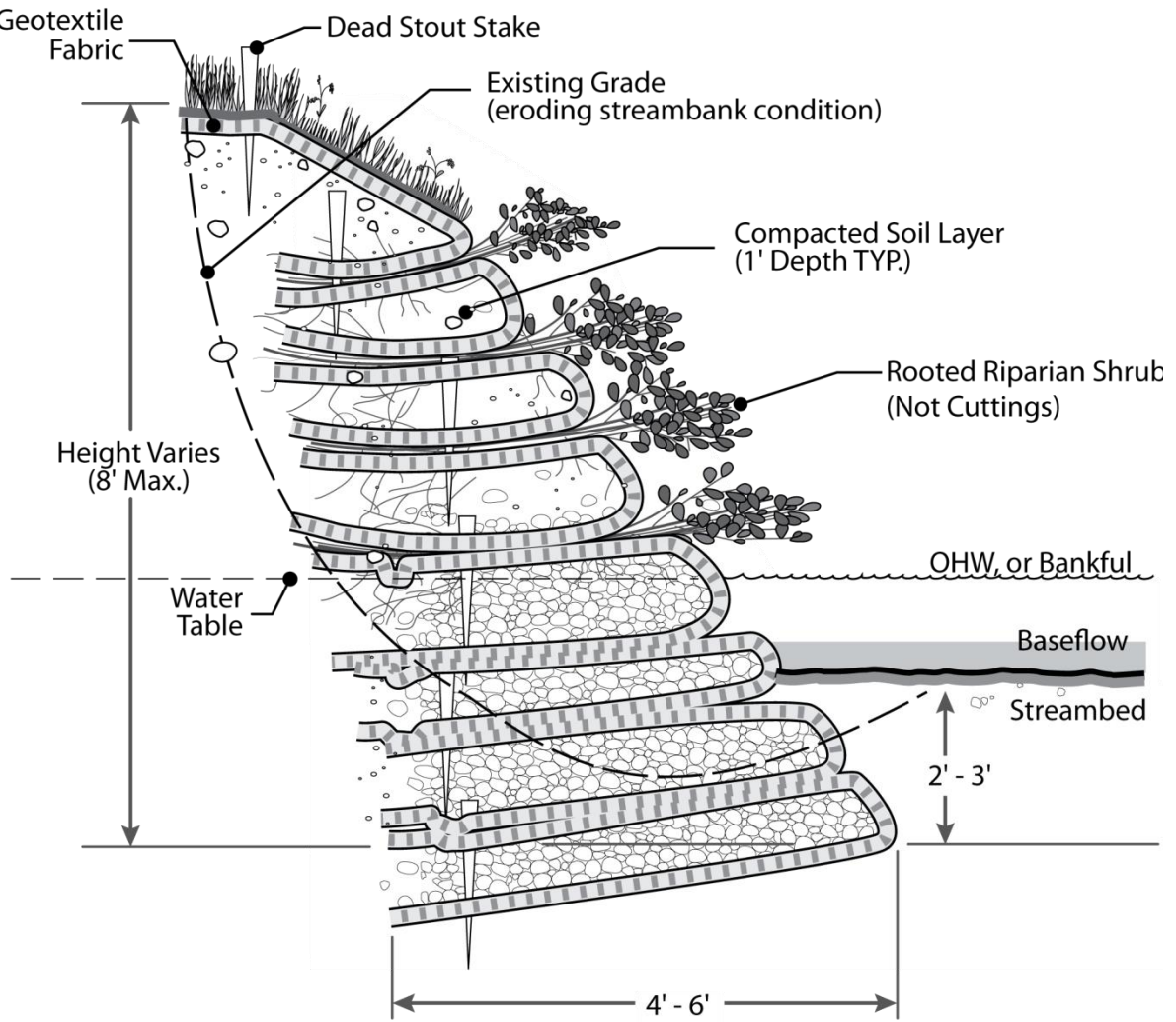

Figure 30. Vegetated Geogrid (Adapted with permission from Eubanks and Meadows 2002).



Figure 31. Vegetated soil lifts used to protect high value infrastructure on the Cache la Poudre River, Fort Collins, CO. Two seasons post-construction. From Giordanengo, J. H. Reprinted with permission.

8.5 CONCLUDING REMARKS

The successful use of integrated bioengineering treatments in a wide variety of streambank stabilization scenarios throughout Colorado makes them a promising tool for river and floodplain restoration. While they are not appropriate for every imaginable impaired site, the engineered blend of biological and physical materials provides for both short- and long-term protection that is appropriate for a wide range of conditions. In essence, integrated treatments are the epitome of what bioengineering aspires to accomplish. Beyond the bank protection provided by integrated treatments, combining such treatments with stream channel stability treatments, floodplain enhancements, bank grading, and a wide variety of other floodplain improvements can lead to lasting resiliency for Colorado streams.

9.0 MANAGEMENT, MAINTENANCE, AND MONITORING

Management, maintenance, and monitoring programs are often overlooked during the planning phases of a river restoration project, resulting in little attention being paid to the very elements critical to long-term project success. Because site management, post-construction maintenance, and monitoring activities are often a fraction of total project cost, their inclusion in a budget provides relatively high value. Given the strong interaction between management, maintenance, and monitoring activities, designing such activities should be undertaken in an integrated manner. When such program activities are integrated well, it is possible to relate key elements of each activity (i.e., monitoring) to the impacts provided by the two other activities (i.e., management and maintenance). For example, the monitoring methodologies used to determine the condition of bioengineering treatments over time will inform maintenance actions in a way that supports long-term site management plans.

9.1 MANAGEMENT

Before designing a bioengineering project, it is important to understand the land use practices (recreation, grazing, conservation, etc.) that will direct long-term management of a site. A diversity of management plans may be in place for a given project site depending on the type of land ownership (public vs. private), planned land use activities, budgets, and land use philosophies. A common theme among most management plans is the concept of *adaptive management*. Adaptive management is an iterative process, incorporating monitoring results to inform ongoing maintenance and operations of a site.

Evaluation of monitoring data can answer questions such as:

- ◆ Were the appropriate treatments developed, given design criteria and goals?
- ◆ Were the designed structures correctly implemented?
- ◆ Were project outcomes achieved according to project goals?
- ◆ Are management activities (boating, hiking, grazing, other land use) negatively affecting project outcomes?
- ◆ Have site conditions changed in a way that requires an adjustment to existing structures, replacement of structures, or addition of new structures?
- ◆ Is the desired vegetation community on the expected establishment trajectory, or are important components missing?

- ◆ Have invasive or noxious species negatively impacted the site?

Although site management is best considered before project implementation, it will need to be addressed throughout the life of a project. Ultimately, the long-term success of a project is only possible through the adequate integration of monitoring, maintenance, and good site management.

Invasion of Non-native Plants

Risk

Invasive and/or noxious plants (hereinafter referred to as “invasive plants”) have long been recognized as ecologically and economically detrimental for multiple reasons. Colorado harbors a great number of aggressive species capable of out-competing native plants for water, light, and nutrients, while providing minimal benefits such as soil stabilization, forage, and other wildlife and pollinator benefits in comparison to native vegetation. Invasive plants have an advantage over native species in part because they lack the full spectrum of biological controls (i.e., insect predators, plant diseases, etc.) that serve to keep their populations in check in their country of origin. As such, they are more likely to continue to spread unabated throughout a watershed by displacing native plants and forming dense monocultures, especially where anthropogenic (i.e., land clearing, road networks, and alterations in natural hydrology) or natural disturbance (i.e., flood, fire, etc.) provide an opportunity for invasion.

Invasive riparian species include deep rooted shrubs and small trees such as salt cedar (*Tamarix* spp.) and Russian-olive (*Elaeagnus angustifolia*), and larger trees such as Siberian elm (*Ulmus pumila*) and crack willow (*Salix fragilis*). Such invasive trees tend to displace cottonwoods and willows, and are correlated with dense stands of invasive herbaceous species beneath them. Additionally, some invasive species, exhibit allelopathic tendencies such as exuding salt through the leaves and into the soil, resulting in poor habitat for native riparian species.

The most cost-effective time to manage invasive vegetation is early in a project’s lifetime, before invasive plants have a chance to spread through abundant seeds or vegetative propagules. Because consistent monitoring and follow-up treatment is required to address most invasive species problems, such activities should be budgeted for during early planning phases. For most construction projects, management of invasive plants should take place multiple seasons before work activities begin, as soil disturbance of any kind can stimulate seedling establishment and vegetative reproduction (i.e., rhizomatous spread) throughout the site.

Opportunity

Treating invasive species is an opportunity to restore an area back to a more productive and natural condition, increase biodiversity, and can provide greater protection of slopes and banks. There is also a legally binding obligation for the removal/control of noxious species as required by the Colorado

Noxious Weed Act (C.R.S. 35-5.5-101-119). As such, streambank bioengineering projects represent opportunities to engage county or state land managers for the control of invasive plants. Invasion of non-native vegetation can be mitigated (but not eliminated) in the following ways:

- ◆ Pre-treating the project site to remove invasive and noxious species;
- ◆ Selecting appropriate and diverse early-seral seed mixes with the potential to fully occupy a given area's botanical niches;
- ◆ Using appropriate seeding rates and seeding methods;
- ◆ Applying appropriate levels of soil amendments, as determined by proper soil testing;
- ◆ Minimizing or eliminating the use of nitrogen, as invasive species are preferentially stimulated over native species through the use of nitrogen;
- ◆ Paying close attention to the invasive species seeds that are often present in a seed mix; and
- ◆ Developing an iterative weed management plan, informed by regularly scheduled monitoring.

Because invasive plants provide some level of bank protection, harbor wildlife, and may be shading the stream and adding organic matter to the river, removal of invasive plants such as Russian olive and Siberian elm should be considered in phases. By the time desirable vegetation becomes well established, final phases of invasive tree removal can be completed. Most invasive species can be treated with selective herbicides that, when applied correctly, will not harm desired native grasses. Therefore, one strategy to treat a heavily infested area of invasive plants is to:

- ◆ Seed early with a native grass mix;
- ◆ Return in successive years, to treat non-native plants; and
- ◆ Return in success years to either inter-seed or direct-plant herbaceous dicot (forb) species, as well as woody vegetation (assisting in the reintroduction of diverse pollinator and wildlife-friendly plants).

In areas where invasive species cover is not extensive, seeding with an appropriate seed mix can often keep the invasive species suppressed (e.g., via competition and niche occupation by desired natives). When invasive plants are mechanically removed, it is important that the entire root system be killed, as removing or affecting the visible top portion will likely not accomplish long-term reductions in the population. While mechanical removal (i.e., deadheading, digging up roots, or the clear and grub approach) may be somewhat effective for some species, most invasive species are

effectively treated with systemic herbicides, grazing and other biocontrols, or a combination of all of these treatment methods (i.e., *integrated pest management*, or IPM). Many herbicides work slowly and require a month-long period of non-disturbance following application. The Colorado Department of Agriculture, County Weed Managers, CSU Extension offices, and Conservation Districts, are good sources of weed management recommendations. Colorado law (C.R.S. 35-5.5-101-119) requires applicators to be certified by the CDA when making herbicide recommendations to a client .

When managing invasive vegetation in a riparian area, it is essential to read the herbicide label. The label will contain information relating to approved sites, proper application rates, timing, soil residual/plant back intervals, and species controlled. As many herbicides are toxic to fish and aquatic invertebrates, care must be taken when working in riparian areas to select products that are approved specifically for aquatic use. If there is risk of contamination to water (i.e., through drift or spills), aquatic approved herbicides must be used. When applying herbicides in riparian areas and/or aquatic sites, be sure to check that your local governing agency has a Pesticide General Permit under the National Pollution Discharge Elimination System.

In addition to being aware of the negative effect invasive plants can have on desired native vegetation, designers and implementers must consider the impact domestic livestock and wildlife can have on newly planted vegetation.

Livestock and Wildlife Control

Unmanaged impacts from livestock or wildlife in a revegetation site can be devastating to newly established plant materials. As such, livestock should be excluded from the restored site for a period of four to five years after establishment. If livestock access to water is critical, offsite watering (i.e., stock ponds or tanks) or hardened water crossings should be used to reduce impact to revegetation areas during the grazing season. For areas where livestock is a concern, a grazing management plan will be essential (Washington State Department of Fish and Wildlife et al., 2003). Once riparian vegetation is well established, livestock grazing can resume as part of a well-managed grazing plan. When managed correctly, livestock can have beneficial impacts to riparian and adjacent upland plant communities.

Waterfowl can also cause significant damage to a new planting. Various types of fences, tape, rope, wire, and balls can be effective protective measures. In moderate to high recreation areas, human traffic (i.e., fishing, boating, picnicking, etc.) can cause substantial bank erosion in treated areas. In many cases, adequate signage and temporary exclusion fencing can help alleviate these impacts.

While proper grazing management is beyond the scope of this manual, the following tips are provided to help minimize grazing impacts:

- ◆ A combination of fencing and hardened water crossings, when designed correctly, can allow for grazing in a floodplain while providing access to water and protecting

restored vegetation. Once vegetation is established (four to eight years), properly managed seasonal grazing patterns (i.e., deferred rotation) can occur in riparian areas with minimal damage to vegetation.

- ◆ Protective cages (wire mesh, plastic mesh, etc.) can be applied to protect key individual plants until their roots are well established and their leaves and stems are high enough to be safe from grazing animals, or robust enough to sustain moderate levels of grazing.
- ◆ Chemicals such as hot pepper spray (6% hot sauce and 92% water), deodorized predator (i.e., fox, wolf, or coyote) urine, and other manufactured products have proven effective at reducing herbivory by deer and to some degree elk. Typically, such chemicals should be applied monthly or bi-monthly (depending on precipitation and season) to maintain effectiveness.
- ◆ Plastic collars (i.e., corrugated pipes with a vertical slit) can be used around the trunks of trees such as cottonwoods to reduce damage from rabbits, gophers, and other animals that. In areas where below-ground herbivory is expected, collars should be installed one to two inches below grade, and extend 16 inches above grade.
- ◆ A slurry of cement and paint can be applied to the trunks of woody vegetation to discourage beaver predation.

9.2 MAINTENANCE

Maintenance is the collection of actions taken to help ensure a given stream restoration project performs as designed and attains project objectives (NRCS, 2007). Maintenance is closely tied to management, and involves the initial set of planned activities as well as unplanned activities following project implementation. If lack of maintenance becomes chronic, substantial efforts may be required in correct failures in structures or other design elements. Active and frequent maintenance can often result in reduced “reconstruction” costs down the road.

Maintenance is most beneficial in the first three to five years following planting, with the exception of the occurrence of significant (i.e., 50 years or greater) flood events. Excessive flood flows soon after planting can cause substantial erosion and slope failure, resulting in unacceptable soil and plant loss. Such areas may need to be replanted, inter-planted, or reinforced by other means. Other maintenance efforts may include: (a) placement of large woody debris and other toe protection treatments on banks to redirect water away from the established areas, (b) invasive species management, (c) supplemental irrigation, and (d) fencing.

By understanding the range of post-construction stressors (biotic and abiotic) that can potentially impact a bioengineered streambank, the design process is likely to develop optimal treatments necessary to minimize post-construction maintenance needs.

9.3 MONITORING

Monitoring is the process of measuring or assessing specific physical, chemical, and/or biological parameters of a project (Thayer et al., 2003; NRCS, 2007) over time. Using *subjective* (i.e., qualitative), or *objective* (i.e., quantitative) methods, monitoring can be used to help identify and alleviate potential stressors and inform maintenance activities. Qualitative methods, such as visual monitoring (i.e., repeat photographic points or completion of subjective scoring sheets), can effectively document site changes, and can quickly suggest maintenance activities necessary to correct problems. Rigorous observation can identify if stabilization treatments have failed, and may indicate where repairs are necessary. The results provided by monitoring, when conducted in a scientific manner, may also be used to guide the criteria and methodology for future restoration projects.

Quantitative monitoring, conversely, is more data-driven and aims to measure project outcomes through scientifically-accepted methods aimed at reducing observer bias. Variables assessed typically include but are not limited to:

- ◆ Species composition (aquatic and terrestrial);
- ◆ Measures of vegetative growth and change over time;
- ◆ Population estimates (benthic macroinvertebrate, fish and birds);
- ◆ Bank erosion;
- ◆ Vegetation survival rates;
- ◆ Degree of failure/success of installed structures;
- ◆ Streamflow measures; and
- ◆ Groundwater elevations.

9.4 REFERENCE CONDITIONS AND REFERENCE REACH

When developing monitoring programs, the use of reference areas are important for determining the degree to which restored sites meet pre-disturbance conditions. While pristine conditions, are difficult to locate for vegetation communities and stream conditions, some fundamentals of using a reference reach is provided here. The *reference reach* is a riverine system that has adjusted to the boundary conditions, and flow and sediment regimes, in such a way as to be self-maintaining. Reference

reaches do not necessarily represent pristine systems (Hughes, Larsen, & Omernik, 1986) as the boundary conditions and driving variables have been greatly impacted by natural and anthropogenic influences. Rather, reference reaches are based on the theory and central tendency that rivers progress toward their most probable form following disturbance (Mackin, 1948; Leopold, 2006). A thorough understanding of evolution or successional states through various stages of adjustment is required through time-trends of river change and historical evidence.

Reference reaches are selected based on the potential conditions of the impaired, existing reach and are initially stratified by landscape type and stream type to integrate fluvial processes and minimize variance in relationships. Reference reaches must also be stratified by specific conditions of the flow and sediment regimes and the riparian vegetation community that vary within a landscape type. Stream order, following the work of Horton (1945) and Strahler (1957), and stream size must also be considered.

Reference reaches are selected for purposes of assessment and restoration by establishing dimensionless relations that represent the stable morphology for a given landscape and stream type. For physical and ecological assessments, a departure analysis is conducted that compares the existing reach inventory to the reference reach (Rosgen, 2011). The comparisons between the impaired reach and reference reach inventories can indicate accelerated processes of streambank erosion, aggradation, degradation, and channel enlargement. The dimensionless relations of the reference reach are also used to develop the morphological variables to be constructed (such as channel width, depth, and slope) for the proposed design reach. Ranges of values are determined for each morphological variable to represent the natural variability inherent within a stable river system. The range of values also provide flexibility in design (to prevent uniform pattern layout) and criteria used to establish an acceptable range of natural variability of the stable morphology for post-restoration and post-runoff observations.

9.5 MONITORING CRITERIA AND METHODS

A variety of criteria can be developed to evaluate project results, depending on the questions being asked. Hydrological criteria may include channel width-to-depth ratio or scour and deposition rates. Biological criteria may include plant density, vigor, species composition, the use of indicator species (i.e., select native fish and stream invertebrates), and the use of the index of ecological integrity (Andreasen, O'Neill, Noss, & Slosser, 2001). Monitoring for water quality parameters may be important if the goal of the project is to improve qualities such as temperature, sediments, nutrients, pathogens and other pollutants. The reference area should reflect the more biologically productive and stable stream channel, which is as close as possible to natural conditions. It is possible to have multiple reference sites for a given project; with one providing guidelines for revegetation, while another is more suited to provide input concerning hydrologic goals.

Continued monitoring for invasive species is essential, as the seeds and root biomass of many invasive species can survive for decades in a dormant state. It is most effective to treat invasive species upon emergence and before they have time to spread and reseed. Identifying planted materials by marking or tagging the plants will help distinguish them from natural recruitment. Many monitoring results are most relevant when compared to baseline (i.e., pre-project) conditions, and when equivalent protocols are used in the baseline and ongoing evaluation monitoring efforts.

When more statistically-robust outcomes are required, a *control site* (i.e., a similarly disturbed site that does not receive treatments) should be evaluated against the treated site. A control site will help demonstrate the types and degree of changes that occur through normal successional processes versus those changes that occur as a result of bioengineering treatments. When monitoring vegetation, a sample adequacy calculation (Chambers & Brown, 1983) can be used to determine the minimum number of transects required to statistically account for the variability in results among the transects. No more sampling points should be established than would be necessary for valid statistical inference.

Lewis et al. (2009) and references therein recommend four fundamental monitoring types to answer principle questions:

- ◆ What are the existing site conditions and the reasons for project implementation?

Monitoring type: *Pre-project assessment* (i.e., documentation of the current site conditions and how they inform project selection and design).

- ◆ Was the project installed according to design specifications, permits and landowner agreements?

Monitoring type: *Implementation monitoring* to confirm that the project was implemented according to the approved designs, plans, and permits.

- ◆ Did attributes and components at the project site change in magnitude expected over the appropriate time frame?

Monitoring type: *Effectiveness monitoring* is used to assess post-project site conditions and document changes resulting from the implemented project. This is accomplished through comparison with pre-project conditions.

- ◆ Did fish, wildlife, or water quality respond to the changes in physical and biological attributes or components brought about by the project?

Monitoring type: *Validation monitoring* is used to determine the cause and effect relationship between the project and biotic or physical response.

The timeframe and frequency of monitoring should be taken into consideration prior to project implementation. Following baseline monitoring, the duration of post-construction sampling should take place over a length of time necessary to understand if project objectives have been achieved. While desired vegetation cover might be ascertained within three years, it may take 10 years or longer to determine if proper canopy closure goals and plant community composition have been achieved or are on the desired trajectory. For the first three years, it is recommended that monitoring be conducted at least once per year. Subsequent monitoring can take place every three to five years to document mid-term site changes. However, in the case of unusually high-flow events, monitoring should take place as soon as possible.

Depending on the questions addressed, regulatory requirements, budgets, and other resource constraints, a great variety of monitoring treatments are available. While a complete list and description of monitoring methods is beyond the scope of this manual, following are a few common methods and procedures:

- ◆ Cross-section and latitudinal transects to measure geomorphic changes over time (Hardy, Panjan, & Mathias, 2005);
- ◆ Line-intercept procedure (Herrick, Van Zee, Haustad, Burkett, & Whitford, 2005) to measure plant community composition, especially herbaceous vegetation. This method is highly accurate and repeatable over time;
- ◆ Daubenmire Method (Daubenmire, 1959);
- ◆ Kick net procedure for aquatic invertebrate communities. Because aquatic invertebrate communities are a cost-effective and powerful way to track project effectiveness over time, a single aquatic invertebrate sample should be collected at each site pre- and post-construction. Standard metrics (i.e., EPA) should be used to characterize the aquatic community pre- and post-construction;
- ◆ Electrofishing to quantify age class distribution and population density; and
- ◆ Bank Erosion Hazard Index (Rosgen, 2001, March), by itself or coupled with the Near Bank Shear Index (Bank Assessment for Non-point source Consequences of Sediment, BANCS).

Because there is no one method that will answer every question, a combination of monitoring methods is likely required. When budgets are limited, even the most basic monitoring methods can inform adaptive management decisions important to the long-term maintenance of a project. An important key, regardless of the complexity or cost of the monitoring method(s) used, is to use repeatable methods over time. As personal and management circumstances change over time, data

should be collected and managed in a way that can be easily understood and interpreted by a variety of future land managers and practitioners..

9.6 CONCLUDING REMARKS

The breadth of interest in bioengineering among engineers, ecologists, planners, and across public, private, and non-profit sectors, is an indication of the broad-based desire to address streambank stability in a manner that enhances ecological functionality and resilience. Throughout this manual, it has been the aim of the authors to present appropriate levels of science and experience that highlight the importance of bioengineering treatments for stream restoration and bank stabilization. Because no single resource can adequately cover the engineering, science, and policy principles necessary to successfully plan and implement successful bioengineering and river restoration projects, the reader is encouraged to read the references presented below. With an interdisciplinary and professional team in place, and with an understanding of the subject matter presented in this manual, ample reasons exist to incorporate a variety of bioengineering treatments into your next project. In the long term, there is far more to be gained by trying something new than by sticking with that which is antiquated.

REFERENCES

- Abbe, T., & Brooks, A. (2011). Geomorphic, engineering, and ecological considerations when using wood in river restoration. In A. Simon, S.J. Bennett, & J.M. Castro (Eds.), *Stream Restoration in Dynamic Fluvial Systems: Scientific Approaches, Analyses, and Tools*, (Geophysical Monograph 194). (pp. 419-451). Washington, DC: American Geophysical Union.
- Abbe, T. Embertson, L., Bruzgul, J., and Maher, K. (2014). Risk Considerations. Draft Chapter Prepared for/In Large Wood National Manual: Guidelines for Planning, Design, Placement and Maintenance of Large Wood in Fluvial Ecosystems: Restoring Process, Function and Structure, U. S. Army Corps of Engineers and Bureau of Reclamation, January 2014 (Technical Review Draft).
- Abernathy, B. & Rutherford, I. D. (1998). Where along a river's length will vegetation most effectively stabilize streambanks? *Geomorphology* 23(1), 55-75.
- Abernathy, B. & Rutherford, I. D. (2000). The effect of riparian tree roots on the mass-stability of riverbanks. *Earth Surface Processes and Landforms* 25(9), 921-937.
- Abernathy, B. & Rutherford, I. D. (2001). The distribution and strength of riparian tree roots in relation to riverbank reinforcement. *Hydrological Processes* 15(1), 63-79.
- Ackerfield, J. (2015). *The Flora of Colorado*. Fort Worth, TX: Botanical Research Institute of Texas Press.
- Aldridge, B. N., & Garrett, J. M. (1973). *Roughness Coefficients for Stream Channels in Arizona* (USGS Open-File Report 73-3), Tucson, AZ: U. S. Geological Survey.
- Anderson, B. G. (2006). Quantifying the Interaction Between Riparian Vegetation and Flooding: From Cross-Section to Catchment Scale. (Doctoral Dissertation, The University of Melbourne, AU, 2006).
- Andreasen, J. K., O'Neill, R. V., Noss, R. & Slosser, N. C. (2001). Considerations for the development of a terrestrial index of ecological integrity. *Ecological Indicators* 1, 21-35.
- Annandale, G. W. (2006). *Scour Technology: Mechanics and Engineering Practice*. New York: McGraw-Hill. (pp. 99-107, 115-120).
- Arcement, G. J., Jr. & Schneider, V. R. (1989). *Guide for Selecting Manning's Roughness Coefficients for Natural Channels and Flood Plains* (U.S. Geological Survey Water-Supply Paper 2339).

- Prepared in cooperation with the U.S. Department of Transportation. Denver, CO: U. S. Department of the Interior, U.S. Geological Survey.
- Bagnold, R. A. (1966). *An approach to the sediment transport problem from general physics*. (US Geological Survey Professional Paper 422-I). Washington, DC: U.S. Government Printing Office.
- Bagnold, R. A. (1980). An empirical correlation of bedload transport rates in flumes and natural rivers. *Proceedings of the Royal Society of London A: Mathematical and Physical Sciences*, 372 (1751), 453-473. London, UK: Royal Society of London.
- Barnes, H. H. (1967). *Roughness Characteristics of Natural Channels* (U.S. Geological Survey Water Supply Paper 1849) Washington, DC: U.S. Government Printing Office.
- Barr, S., Jonas, J. L., & Paschke, M. W. (2015). *Optimal Seed Mixtures and Seeding Rates for Restoration of Surface Disturbances on Semiarid Grasslands*. Masters Thesis (Manuscript in Review). Colorado State University, Fort Collins, CO.
- Bathurst, J. C. (1985). Flow Resistance Estimation in Mountain Rivers. *Journal of Hydraulic Engineering*, 111(4), 625-643.
- Beeson, C. E., & Doyle, P. F. (1995). Comparison of Bank Erosion at Vegetated and Non-Vegetated Channel Bends. *Journal of the American Water Resources Association*, 31(6), 983-990.
- Bertoldi, W., Gurnell, A. M., & Drake, N. A. (2011). The topographic signature of vegetation development along a braided river: Results of a combined analysis of airborne lidar, color air photographs, and ground measurements. *Water Resources Research*, 47(6), W06525 (13 p.).
- Bledsoe, B. & Wohl, E. (2016). *Large Wood Structure Stability Analysis Tool*. Retrieved online (on 03/27/2016) at CSU College of Engineering's website: <http://www.engr.colostate.edu/~bbledsoe/streamtools/>
- Bowie, A. J. (1982). Investigations of vegetation for stabilizing eroding streambanks. *Transactions of the American Society of Agricultural Engineers*, 25(6), 1601-1606.
- Brooks, A. P., & Brierley, G. J. (2002). Mediated equilibrium: The influence of riparian vegetation and wood on the long-term evolution and behaviour of a near-pristine river. *Earth Surface Processes and Landforms*, 27(4), 343-367.
- Brownlie, W. R. (1983). Flow depth in Sand-Bed Channels. *Journal of Hydraulic Engineering* 109(7), 959-990.

- Brunner, G. W. (2010). *HEC-RAS: River Analysis System Hydraulic Reference Manual, Version 4.1*. (CPD-69). Davis, CA: U. S. Army Corps of Engineers, Hydrologic Engineering Center.
- Bundesministerium fuer Land- und Forstwirtschaft (1994). *Schutzwasserbau –Gewaesserbetreuung – Oekologie*. Grundlagen für Wasserbauliche Massnahmen an Fliessgewaessern. Vienna, AT: Bundesministerium fuer Land- und Forstwirtschaft.
- Bunte, K., Abt, S. R., Swingle, K. W., & Cenderelli, D. A. (2014). Effective discharge in rocky mountain headwater streams. *Journal of Hydrology*, 519, 2136-2147.
- Buraas, E. M., Renshaw, C. E., Magilligan, F. J., & Dade, W. B. (2014). Impact of reach geometry on stream channel sensitivity to extreme floods. *Earth Surface Processes and Landforms*, 39(13), 1778-1789.
- Bureau of Reclamation and U.S. Army Engineer Research and Development Center (USBR and ERDC). 2016. National Large Wood Manual: Assessment, Planning, Design, and Maintenance of Large Wood in Fluvial Ecosystems: Restoring Process, Function, and Structure. 628 pages + Appendix. Available: www.usbr.gov/pn/ and <http://cwenvironment.usace.army.mil/restoration.cfm> (click on “River Restoration,” then “Techniques”).
- Cancienne, R. M., Fox, G. A., & Simon, A. (2008). Influence of seepage undercutting on the stability of root-reinforced streambanks. *Earth Surface Processes and Landforms*, 33(11), 1769-1786.
- Chambers, J. C. & Brown, R. W. (1983). *Methods for Vegetation Sampling and Analysis on Revegetated Mined Lands* (General Technical Report INT-151). Ogden, UT: U. S. Department of Agriculture, Forest Service, Intermountain Forest and Range Experiment Station.
- Chen, Z. Q. R., Kavvas, M. L., Bandeh, H., Tan, E., Carlson, J., Griggs, T., & Lorenzato, S. (2009). *Study of the Roughness Characteristics of Native Plant Species in California Floodplain Wetlands*. Sacramento: California Department of Water Resources. Retrieved from UC Davis Civil and Environmental Engineering Department, J. Amorocho Hydraulics Laboratory: <http://jahl.engr.ucdavis.edu/research/roughness-study/>
- Clark, M.J & Richards, K.J (2002). Supporting complex decisions for sustainable river management in England and Wales. *Aquatic Conservation-Marine and Freshwater Systems*, 12, 471-783.
- Clements, F. E. (1936). Nature and structure of the climax. *Journal of Ecology*, 24(1), 252-284.
- Cluer, B., & Thorne, C. (2014). A stream evolution model integrating habitat and ecosystem benefits. *River Research and Applications*, 30(2), 135-154.

- Colorado Natural Heritage Program (2016). CNHP Tracked Vascular Plant Species [web application]. Fort Collins, CO: Colorado Natural Heritage Program, Colorado State University. Retrieved online (on 03/28/2016) at Colorado Natural Heritage Program's website: <http://www.cnhp.colostate.edu/download/list/vascular.asp>.
- Connell, J. H. & Slater, R.O. (1977). Mechanisms of succession in natural communities and their role in community stability and organization. *The American Naturalist* 111(982), 1119-1144.
- Cooperrider, A. Y., Boyd, R. J., & Stuart, H. R. (Eds.). (1986). *Inventory and monitoring of wildlife habitat*. Denver, CO: U.S. Department of the Interior, Bureau of Land Management.
- Copeland, R. R., McComas, D. N., Thorne, C. R., Soar, P. J., & Fripp, J. B. (2001). *Hydraulic Design of Stream Restoration Projects* (ERDC/CHL TR-01-28). Vicksburg, MS: U.S. Army Engineer Research and Development Center, Coastal and Hydraulics Laboratory.
- Cowan, W. L. (1956). Estimating hydraulic roughness coefficients. *Agricultural Engineering* 37, 473-475.
- Cowles, H. C. (1899) The ecological relations of the vegetation on the sand dunes of Lake Michigan. *Botanical Gazette* 27, 95-117, 167-202, 281-308, 361-391. Cramer, M. L. (Ed.) (2012). *Stream Habitat Restoration Guidelines*. Co-published by the Washington Departments of Fish and Wildlife, Natural Resources, Transportation and Ecology, Washington State Recreation and Conservation Office, Puget Sound Partnership, and the U.S. Fish and Wildlife Service. Olympia, WA: Washington State Aquatic Habitat Guidelines Program.
- Crosato, A., & Saleh, M. S. (2011). Numerical study on the effects of floodplain vegetation on river planform style. *Earth Surface Processes and Landforms*, 36(6), 711-720.
- Daubenmire, R. (1959). A canopy-coverage method of vegetational analysis. *Northwest Science* 33, 43-64.
- Dietrich, W. E., Bellugi, D. G., Sklar, L. S., Stock, J. D., Heimsath, A. M., & Roering, J. J. (2003). Geomorphic transport laws for predicting landscape form and dynamics. In: P. R. Wilcock & R. M. Iverson (Eds.). *Prediction in geomorphology* (American Geophysical Union Geophysical Monograph 135, pp. 103–132) Washington, DC: American Geophysical Union.
- D'Aoust, S. G., & Millar, R. G. (2000). Stability of ballasted woody debris habitat structures. *Journal of Hydraulic Engineering*, 126(11), 810-817.
- Doran, G. T. (1981). There's a S.M.A.R.T. way to write management's goals and objectives. *Management Review* 70(11), 35–36.

- Downs, P. W., & Simon, A. (2001). Fluvial geomorphological analysis of the recruitment of large woody debris in the Yalobusha River network, Central Mississippi, USA. *Geomorphology* 37, 65–91.
- Ellen MacArthur Foundation (2016). *Forest succession* [figure]. Copyright by the Ellen MacArthur Foundation.
- Elliott, J. G. (1979). *Evolution of Large Arroyos: The Rio Puerco of New Mexico*. Unpublished Masters Thesis, Colorado State University, Fort Collins, CO.
- Elliott, J. G., Gellis, A. C. & Aby, S. B. (1999). Evolution of Arroyos: Incised Channels of the Southwestern United States, In S.F. Darby & A. Simon (Eds.). *Incised River Channels: Processes, Forms, Engineering, and Management* (pp. 153-185). Chichester, UK: J Wiley.
- Emergency Watershed Protection Program (2015). *2013 Colorado Flood Recovery Phase 2: Project Engineering Guidance*. Denver, CO: Co-published by Colorado Water Conservation Board and Natural Resources Conservation Service. Retrieved online at Colorado Water Conservation Board website: http://cwcb.state.co.us/environment/watershed-protection-restoration/Documents/EmergWatershed/8_EWP_CO_Engineering_Guidance_Ph2_Final_20150928.pdf
- Eubanks, C. E. & Meadows, D. (2002) *A Soil Bioengineering Guide for Streambank and Lakeshore Stabilization*. Illustrations and details by Jill S. Cremer. San Dimas, CA: U. S. Department of Agriculture, Forest Service, Technology and Development Program.
- Finnegan, N. J., Sklar, L. S., & Fuller, T. K. (2007). Interplay of sediment supply, river incision, and channel morphology revealed by the transient evolution of an experimental bedrock channel. *Journal of Geophysical Research: Earth Surface* 112, F3 (17 p.).
- Fischenich, C. (2000). *Resistance due to vegetation* (Ecosystem Management and Restoration Research Program Technical Notes Collection: ERDC TN-EMRRP SR-07). Vicksburg, MS: U.S. Army Corps of Engineers, Waterways Experiment Station.
- Fischenich, C. (2001). *Stability Thresholds for Stream Restoration Materials*, (Ecosystem Management and Restoration Research Program Technical Notes Collection: ERDC TNEMRRP-SR-29). Vicksburg, MS: U.S. Army Corps of Engineers. Waterways Experiment Station.
- Flores, A. N., Bledsoe, B. P., Cuhaciyar, C. O., & Wohl, E. E. (2006). Channel-reach morphology dependence on energy, scale, and hydroclimatic processes with implications for prediction using geospatial data. *Water Resources Research* 42(6), W06412 (15 p.).

- Fonstad, M. A. (2003). Spatial variation in the power of mountain streams in the Sangre de Cristo Mountains, New Mexico. *Geomorphology* 55(1), 75-96.
- Fripp, J., Hoag, J. C., & Moody, T. (2008). *Streambank soil bioengineering: A proposed refinement of the definition*. (U. S. Department of Agriculture - Riparian/Wetland Project Information Series: 23). Natural Resources Conservation Service
- Garcia, M. H. (Ed.). (2008) *Sedimentation Engineering: Processes, Measurements, Modeling, and Practice* (ASCE Manuals and Reports on Engineering Practice No. 110), Reston, VA: American Society of Civil Engineers Task Committee to Expand and Update Manual 54. Environmental and Water Resources Institute (U.S.).
- Gartner, J. D., Dade, W. B., Renshaw, C. E., Magilligan, F. J., & Buraas, E. M. (2015). Gradients in stream power influence lateral and downstream sediment flux in floods. *Geology* 43(11), 983-986
- Gellis, A. C. (1988). *Decreasing Sediment and Salt Loads in the Colorado River Basin – A Response to Arroyo Evolution*. Unpublished Masters Thesis, Colorado State University, Fort Collins, CO.
- Giordanengo, J. H. & Mandel, R. H. (2015). *Field Guide for Harvesting and Installing Willow and Cottonwood Cuttings*. Co-published by: Denver, CO: Colorado Water Conservation Board. & Fort Collins, CO: Synergy Ecological Restoration [ed.: Available by request from John Giordanengo (john@synergy3.org)]
- Gleason, H. A. (1926). The individualistic concept of the plant association. *Bulletin of the Torrey Botanical Club* 53(1), 7-26.
- Graf, W. L. (1983). Downstream changes in stream power in the Henry Mountains, Utah. *Annals of the Association of American Geographers* 73(3), 373-387.
- Greenway, D. R. (1987). Vegetation and slope stability. In: M.G. Anderson and K.S. Richards (Eds.). *Slope Stability* (pp. 187-230). New York, NY: John Wiley and Sons.
- Grime, J. P. (1979) *Plant strategies and vegetation processes*. New York, NT: John Wiley and Sons.
- Hack, J. T. (1973) Stream-profile analysis and stream-gradient index. *U.S. Geological Survey Journal of Research* 1(4), 421–429. Hardy, T., Panja, P., & Mathias, D. (2005). *WinXSPRO, A Channel Cross Section Analyzer, User's Manual, Version 3.0*. (General Technical Report RMRS-GTR-147). Fort Collins, CO: U.S. Department of Agriculture, Forest Service, Rocky Mountain Research Station.

- Harvey, M. D. & Watson, C. C. (1986). Fluvial processes and morphological thresholds in incised channel restoration, *Journal of the American Water Resources Association* 22(3), 359-368.
- Hawley, R. J., Bledsoe, B. P., Stein, E. D., & Haines, B. E. (2012). Channel Evolution Model of Semiarid Stream Response to Urban-Induced Hydromodification. *Journal of the American Water Resources Association* 48(4), 722-744.
- Herrick, J. E., Van Zee, J. W., Havstad, K. M., Burkett, L. M., & Whitford, W. G. (2005). *Monitoring Manual for Grassland, Shrubland and Savanna Ecosystems. Volume I: Quick Start*. Co-published by: Las Cruces, NM: U. S. Department of Agriculture, Agricultural Research Service, Jornada Experimental Range. Tucson, AZ: University of Arizona Press.
- Herron, C. M., Jonas, J. L., Meiman, P. J., & Paschke, M. W. (2013). Using native annual plants to restore post-fire habitats in western North America. *International Journal of Wildland Fire* 22, 815-821.
- Hey, R. D. (1979). Flow Resistance in Gravel Bed Rivers, *Journal of the Hydraulics Division (American Society of Civil Engineers)* 105(4), 365-379.
- Hicks, D. M., & Mason, P. D. (1998). *Roughness Characteristics of New Zealand Rivers*, (2nd Ed.). Littleton, CO: Water Resource Publications.
- Hoag, J. C., & Fripp, J. (2005). *Streambank Soil Bioengineering Considerations for Semi-Arid Climates*. (U.S. Department of Agriculture - Riparian/Wetland Project Information Series: 18). Aberdeen: U. S. Department of Agriculture, Natural Resources Conservation Service: Plant Materials Center.
- Hoag, J. C., & Landis, T. A. (2001). Riparian Zone Restoration: Field Requirements and Nursery Opportunities. *Native Plants Journal* 2(1), 30-35.
- Horton, R. E. (1945). Erosional development of streams and their drainage basins; hydrophysical approach to quantitative morphology. *Bulletin of the Geological Society of America* 56, 275-370.
- Hughes, R. M., Larsen, D. P. & Omernik, J. M. (1986). Regional reference sites: A method for assessing stream potentials. *Environmental Management* 10(5), 629-635.
- Interagency Advisory Committee on Water Data (1982) *Guidelines for Determining Flood Flow Frequency* (Bulletin #17B for the Hydrology Subcommittee). Reston, VA: U. S. Department of the Interior, U. S. Geological Survey, Office of Water Data Coordination.
- Jackson, R. B., Candell, J., Ehleringer, J. R., Mooney, H. A., Sala, O. E., & Schulze, E. D. (1996). A global analysis of root distributions for terrestrial biomes. *Oecologia* 108, 389-411.

- Jain, V., Preston, N., Fryirs, K., & Brierley, G. (2006). Comparative assessment of three approaches for deriving stream power plots along long profiles in the upper Hunter River catchment, New South Wales, Australia. *Geomorphology* 74(1), 297-317.
- Jarrett, R. D. (1984). Hydraulics of High-Gradient Streams. *Journal of Hydraulic Engineering* 110(11), 1519–1539.
- Jarvela, J. (2002). Flow resistance of flexible and stiff vegetation: a flume study with natural plants. *Journal of Hydrology* 269(1-2), 44–54.
- Johnson, R. R., Haight, L. T., & Simpson, J. M. (1977). Endangered species vs. endangered habitats: a concept. In R. R. Johnson, D. A. Jones, & Arizona Game and Fish Commission (Eds.). *Importance, Preservation and Management of Riparian Habitat: A symposium, Tucson, Arizona, July 9, 1977*. (USDA Forest Serv. Gen. Tech. Rep. RM-43:68-79). Fort Collins, CO: U. S. Department of Agriculture, Forest Service, Rocky Mountain Forest and Range Experiment Station.
- Julien, P. Y. (1995). *Erosion and Sedimentation*. New York: Cambridge University Press.
- Klasz, G., Reckendorfer, W., & Gutknecht, D. (2012, September). Morphological aspects of bankfull and effective discharge of gravel-bed rivers and changes due to channelization. In: *9th International Symposium on Ecohydraulics 2012, Proceedings*, Vienna, AT. Retrieved online (on 03/18/2016) at Research Gate's website: https://www.researchgate.net/publication/237150556_Morphological_aspects_of_bankfull_and_effective_discharge_of_gravel-bed_rivers_and_changes_due_to_channelization
- Kline, M., Alexander, C., Pytlík, S., Jaquith, S., & Pomeroy, S. (2009). Appendix O: Particle Entrainment and Transport. In: *Vermont Stream Geomorphic Assessment Phase 3 Handbook: Survey Assessment*. Montpelier, VT: Vermont Agency of Natural Resources. Retrieved online (on 01/29/2016) at Vermont Watershed Management Division website: http://www.vtwaterquality.org/rivers/docs/assessmenthandbooks/rv_apxoshearstress.pdf
- Knighton, D. (1998) *Fluvial Forms and Processes: A New Perspective*. New York, NY: Oxford University Press.
- Knighton, A. D. (1999). Downstream variation in stream power. *Geomorphology* 29(3), 293-306.
- Lagasse, P. F., Clopper, P. E., Zevenbergen, L. W., & Ruff, J. F. (2006). *Riprap design criteria, recommended specifications, and quality control* (National Cooperative Highway Research Program (NCHRP) Report 568)) Washington, DC: U. S. Department of Transportation: Federal Highway Administration: Transportation Research Board.

- Lagasse, P. F., Clopper, P. E., Thornton, C. I., Shields, F. D., Jr., McCullah, J. & Spitz, W. J. (in review) *Evaluation and Assessment of Environmentally Sensitive Stream Bank Protection Measures* (National Cooperative Highway Research Program (NCHRP Project No 24-39)). Washington, DC: National Research Council: Transportation Research Board: National Cooperative Highway Research Program.
- Lagasse, P. F., Zevenbergen, L.W., Spitz, W. J., & Arneson, L. A. (2012). *Stream Stability at Highway Structures: Hydraulic Engineering Circular No. 20* (4th Ed.; HIF-FHWA-12-004) Washington, DC: Federal Highway Administration.
- Larsen, I. J., & Montgomery, D. R. (2012) Landslide erosion coupled to tectonics and river incision. *Nature Geoscience* 5(7), 468–473.
- Lane, E. W., & Borland, W. M. (1954). River-bed scour during floods: *Transactions of the American Society of Civil Engineers* 119, 1069-1079.
- Langendoen, E. J. & Simon, A. (2008). Modeling the evolution of incised streams II: Streambank erosion. *Journal of Hydraulic Engineering* 134(7), 905-915.
- Langendoen, E. J., Lowrance, R. R., & Simon, A. (2009). Assessing the impact of riparian processes on streambank stability. *Ecohydrology* 2(3), 360-369.
- Lecce, S. A. (1997). Spatial patterns of historical overbank sedimentation and floodplain evolution, Blue River, Wisconsin. *Geomorphology* 18(3), 265-277.
- Leopold, L. B. (2006). *A View of the River*. Cambridge, MA: Harvard University Press.
- Lewis, D., Lennox, M. & Nossaman, S. (2009). *Developing a Monitoring Program for Riparian Revegetation Projects* (University of California Division of Agriculture and Natural Resources. Publication 8363). Davis, CA: University of California Division of Agriculture and Natural Resources. Retrieved online at: <http://anrcatalog.ucanr.edu/pdf/8363.pdf>
- Li, S. S. & Miller, R. G. (2010). A two-dimensional morphodynamic model of gravel-bed river with floodplain vegetation. *Earth Surface Processes and Landforms* 36(2), 190–202.
- Limerinos, J. T. (1970). Determination of the Manning Coefficient from Measured Bed Roughness in Natural Channels (U.S. Geological Survey Water Supply Paper 1898-B). Washington, DC: U. S. Government Printing Office.
- Lichvar, R. W., Butterwick, M., Melvin, N. C. & Kirchner, W. N. (2014). The National Wetland Plant List: 2014 Update of wetland ratings. *Phytoneuron* 2014-41: 1-42.
- Lutes, D. C. (Ed.). (2006). *FIREMON: Fire Effects Monitoring and Inventory System*. (General Technical Report RMRS-GTR-164-CD). Fort Collins, CO: U. S. Department of Agriculture: Forest Service: Rocky Mountain Research Station.

- Mackin, J. H. (1948), Concept of the graded river. *The Geological Society of America Bulletin*, 59(5), 463–512.
- Magilligan, F. J. (1992). Thresholds and the spatial variability of flood power during extreme floods. *Geomorphology* 5(3), 373-390.
- Mandel, R. H. (2016a) *Revegetation Matrix for Flood Affected Areas of the Colorado Front Range*. Colorado Department of Natural Resources, Colorado Water Conservation Board. [Ed. To be made available at Colorado Water Conservation Board website: <http://cwcb.state.co.us/Pages/CWCBHome.aspx>.]
- Mandel, R. H. (2016b). Personal communication.
- Maryland Department of the Environment (2000) *Maryland's Waterway Construction Guidelines*. Baltimore, MD: Maryland Department of the Environment, Water Management Administration. Retrieved online at the Maryland Department of the Environment's website: http://www.mde.state.md.us/programs/Water/WetlandsandWaterways/DocumentsandInformation/Pages/Programs/WaterPrograms/Wetlands_Waterways/documents_information/guide.aspx
- McCullah, J. & Gray, D. (2005). *Environmentally Sensitive Channel- and Bank-Protection Measures* (National Cooperative Highway Research Program (NCHRP) Report 544). Washington, D.C.: Transportation Research Board. [ed. Includes "Greenbank Decision Support Tool (CD) © Salix Applied Earthcare]
- Natural Resources Conservation Service (1996). Chapter 16: Streambank and Shoreline Protection. In *Engineering Field Handbook* (Part 650) In *National Engineering Handbook*. U. S. Department of Agriculture, Natural Resources Conservation Service.
- Natural Resources Conservation Service (2007). Stream Restoration Design (Part 654). In *National Engineering Handbook*. U. S. Department of Agriculture, Natural Resources Conservation Service. [ed. Includes Technical supplement 14l: Streambank Soil Bioengineering]
- Natural Resources Conservation Service (2012). *Contour Wattles Fact Sheet*. Denver, CO: Natural Resources Conservation Service, Denver Federal Center. Retrieved online at NRCS Colorado's website: www.co.nrcs.usda.gov.
- Natural Resources Conservation Service (2014). *Guidance for Stream Restoration*. (Technical Notes: Engineering 27.3). U. S. Department of Agriculture, Natural Resources Conservation Service. Retrieved online (on 03/14/2016) at NRCS Colorado's website: http://www.nrcs.usda.gov/wps/portal/nrcs/detail/co/technical/?cid=nrcs144p2_063015.

- Natural Resources Conservation Service (2015). Introduction to Ecological Site Descriptions. In: *Colorado Electronic Field Office Technical Guide*. U. S. Department of Agriculture, Natural Resources Conservation Service. Retrieved online (on 03/14/2016) at the NRCS Colorado's website: https://efotg.sc.egov.usda.gov/references/public/CO/CO_Intro_to_ESD_2015.pdf.
- Natural Resources Conservation Service (2016). *PLANTS Database*. Greensboro, NC: U. S. Department of Agriculture, National Plant Data Team. Retrieved online (on 03/14/2016) at: <http://plants.usda.gov/java/>.
- Natureserve. (2016) *NatureServe Explorer: An online encyclopedia of life* [web application]. Version 7.0. Arlington, VA.: NatureServe. Retrieved online (on 03/28/2016) at NatureServe's website: <http://explorer.natureserve.org>.
- National Center for Atmospheric Research (2007) *22 most damaging floods in Colorado*. Retrieved from The Weather and Climate Impact Assessment Science program website (on 1/21/2016): http://www.assessment.ucar.edu/flood/flood_table.html.
- Neary, V. S., Constantinescu, S. G., Bennett, S. J., & Diplas, P. (2012). Effects of Vegetation on Turbulence, Sediment Transport, and Stream Morphology. *Journal of Hydraulic Engineering* 138(9), 765-776.
- Ouimet, W. B., Whipple, K. X., & Granger, D. E. (2009). Beyond threshold hillslopes: Channel adjustment to base-level fall in tectonically active mountain ranges. *Geology* 37(7), 579–582.
- Parker, G. (2006) *1D Sediment Transport Morphodynamics with Applications to Rivers and Turbidity Currents* [e-book]. Retrieved online (on 03/14/2016) at Gary Parker's University of Illinois website: http://hydrolab.illinois.edu/people/parkerg/morphodynamics_e-book.htm
- Persinger, J., Grmusich, K., Culler, C. & Jamison, B. (2013). *Experimental back-sloping with vegetation establishment as an erosion control option for Missouri streambanks*. (Science and Management Technical Series: Number 5). Jefferson City, MO: Missouri Department of Conservation.
- Pettit, N. E. & Naiman, R. J. (2005). Flood-deposited wood debris and its contribution to heterogeneity and regeneration in a semi-arid riparian landscape. *Oecologia* 145(3), 434-444.
- Pezeshki, S.R. (2001). Wetland plant responses to soil flooding. *Environmental and Experimental Botany* 46(3), 299-312.
- Phillips, J. V., McDoniel, D., Capesius, J. & Asquith, W. (1998) *Method to estimate effects of flow-induced vegetation changes on channel conveyances of streams in Central Arizona*. (U.S. Geological Survey Water-Resources Investigations Report 98-4040.) Prepared in cooperation

- with the Flood Control District of Maricopa County. Tucson: U. S. Department of the Interior, U. S. Geological Survey, Information Services.
- Phillips, J. V., & Tadayan, S. (2006) *Selection of Manning's roughness coefficient for natural and constructed vegetated and non-vegetated channels, and vegetation maintenance plan guidelines for vegetated channels in central Arizona* (U.S. Geological Survey Scientific Investigations Report 2006–5108). Prepared in cooperation with the Flood Control District of Maricopa County. Reston: U. S. Department of the Interior, U. S. Geological Survey.
- Poff, N. L., Allan, J. D., Bain, M. B., Karr, J. R., Prestegard, K. L., Richter, B. D., . . . Stromberg, J. C. (1997) The natural flow regime: A paradigm for river conservation and restoration. *Bioscience* 47(11), 769-784.
- Poff, N. L., Richter, B. D., Arthington, A. H., Bunn, S. E., Naiman, R. J., Kendy, E., . . . Warner, A. (2010). The Ecological Limits of Hydrologic Alteration (ELOHA): A New Framework for Developing Regional Environmental Flow Standards. *Freshwater Biology* 55(1), 147–170.
- Pollen, N. & Simon, A. (2005). Estimating the mechanical effects of riparian vegetation on streambank stability using a fiber bundle model. *Water Resources Research* (American Geophysical Union) 41(7), 1-24.
- Pollen, N., Simon, A., & Collison, A. J. C. (2004). Advances in assessing the mechanical and hydrologic effects of riparian vegetation on streambank stability. In: S. J. Bennett and A. Simon (Eds.). *Riparian Vegetation and Fluvial Geomorphology*. (pp. 125-139). Washington, DC: American Geophysical Union.
- Pollen-Bankhead, N. & Simon, A. (2009). Enhanced application of root-reinforcement algorithms for bank-stability modeling. *Earth Surface Processes and Landforms* 34(4), 471-480.
- Pusey, B. J. & Arthington, A.H. (2003). Importance of the Riparian Zone to the Conservation and Management of Freshwater Fish: A review. *Marine and Freshwater Research* 54(1), 1-16.
- Rafferty, M. (2013). *Development of a Computational Design Tool for Evaluating the Stability of Large Wood Structures Proposed for Stream Enhancement*. Masters Thesis. Colorado State University Fort Collins, CO.
- Reinfelds, I., Cohen, T., Batten, P., & Brierley, G. (2004). Assessment of downstream trends in channel gradient, total and specific stream power: a GIS approach. *Geomorphology* 60(3), 403-416.
- Richardson, E.V., Simons, D.B, and Lagasse, P.F. (2001). *River Engineering for Highway Encroachments: Highways in the River Environment*. Federal Highway Administration, Publication No. FHWA NHI 01-004. Hydraulic Design Series Number 6.

- Rocchio, J. (2007). *Floristic quality assessment indices for Colorado plant communities*. Fort Collins, CO: Colorado State University, Colorado Natural Heritage Program. Retrieved online (on 03/28/2016) at Colorado Natural Heritage Program's website: <http://www.cnhp.colostate.edu/download/documents/2007/FQAFinalReport.pdf>.
- Rosgen, D. L. (1993). *Short course on stream classification and applications*. Pagosa Springs, CO: Wildland Hydrology Consultants.
- Rosgen, D. L. (2001, March). A practical method of computing streambank erosion rate. In *Proceedings of the Seventh Federal Interagency Sedimentation Conference* (II: 9-15), Reno, NV. Retrieved online (on 03/14/2016) at Hathi Trust Digital Library's website: <http://babel.hathitrust.org/cgi/pt?id=umn.31951d02024684n;view=1up;seq=243>
- Rosgen, D. L. (2001, August). The Cross-Vane, W-Weir and J-Hook Vane Structures...Their Description, Design and Application for Stream Stabilization and River Restoration. In *Proceedings of the 2001 Wetlands Engineering & River Restoration Conference* (American Society of Civil Engineers) Reno, NV.
- Rosgen, D.L. (2011). Natural Channel Design: Fundamental Concepts, Assumptions, and Methods. pp. 69–93. In A. Simon, S. J. Bennett, & J. M. Castro (Eds.), *Stream Restoration in Dynamic Fluvial Systems: Scientific Approaches, Analyses, and Tools*, (Geophysical Monograph Series 194) Washington, DC: American Geophysical Union.
- Schiechl, H. M., & Stern, R. (1997). *Water Bioengineering Treatments for Watercourse Bank and Shoreline Protection*. Oxford, UK: Blackwell Science.
- Schumm, S. A., Harvey, M.D. & Watson, C.C. (1984). *Incised Channels: Morphology, Dynamics and Control*. Littleton, CO: Water Resources Publications [Ed. Permission granted by Water Resources Publications, Copyright Holder, to adapt "Figure 6-7. Schematic longitudinal profile of an active channel showing identifiable features. Schematic cross section profiles corresponding to reaches on the longitudinal profile show the evolution of the reaches from Type I to Type V. Typical width-depth (F) values are shown. Size of the arrows indicate the relative importance and direction of the dominant processes, degradation, aggradation and lateral bank erosion."]
- Seidl, M. A., Dietrich, W. E., & Kirchner, J. W. (1994). Longitudinal profile development into bedrock: an analysis of Hawaiian channels. *The Journal of Geology* 102(4), 457-474.
- Seiple, R.A., Clark, D. and Colorado Natural Areas Program (Eds.). (1998) *Native Plant Revegetation Guide for Colorado, Caring for the Land Series, Volume III*. Denver, CO: Colorado Natural Areas Program, Colorado State Parks, Colorado Department of Natural Resources. Retrieved

- online (on 03/14/2016) from Colorado Parks and Wildlife's website:
<https://cpw.state.co.us/Documents/CNAP/RevegetationGuide.pdf>
- Shenk, H. J. and Jackson, R. B. (2002). The global biogeography of roots. *Ecological Monographs* 72(3), 311-328.
- Shields, A. (1936). *Anwendung der Ähnlichkeits-mechanik und der Turblenzforschung auf die Geschiebebewegung*. (PhD Thesis / Mitteilungen der Preussischen Versuchsanstalt für Wasserbau und Schiffsbau, Berlin, DE, 1936).
- Shields, F. D., Jr., Cooper, C. M., & Testa, S. (1995). Towards Greener Riprap: Environmental Considerations from Microscale to Macroscale (pp. 557–574). In C. R. Thorne, S. R. Abt, F. B. J. Barends, S. T. Maynard, and K. W. Pilarczyk (Eds.). *River, Coastal, and Shoreline Protection: Erosion Control Using Riprap and Armourstone*, New York, NY: John Wiley & Sons.
- Shields, F. D., Jr., Knight, S. S., & Cooper, C. M. (2000). Cyclic perturbation of lowland river channels and ecological response. *Regulated Rivers: Research and Management* 16(4), 307–325.
- Shields, F. D. Jr., Morin, N., & Cooper, C. M. (2004). Large woody debris structures for sand-bed channels. *Journal of Hydraulic Engineering*, 130(3), 208-217.
- Simões, F. J. (2010, June). Flow resistance in open channels with fixed and movable bed. In *Proceedings of the 2nd Joint Federal Interagency Conference on Sedimentation and Hydrologic Modeling*, Las Vegas, NV. Retrieved online (on 03/25/2016) at USGS's National Research Program's website:
http://water.usgs.gov/nrp/proj.bib/Publications/2010/simoes_2010.pdf
- Simon, A., Curini, A., Darby, S. E., & Langendoen, E. J. (1999). Streambank mechanics and the role of bank and near-bank processes in incised channels (pp. 193-217). In S. F. Darby and A. Simon (Eds.). *Incised river channels: processes, forms, engineering, and management*. Chichester, UK: Wiley.
- Simon, A., Pollen, N. & Langendoen, E. (2006). Influence of two woody riparian species on critical conditions for streambank stability: Upper Truckee River, California. *Journal of the American Water Resources Association* 42(1), 99-113.
- Simon, A., Pollen-Bankhead, N., & Thomas, R. (2011). Development and application of a deterministic bank stability and toe erosion model for stream restoration (pp. 453-474). In: *Stream Restoration in Dynamic Fluvial Systems: Scientific Approaches, Analyses, and Tools*. (Geophysical Monograph Series 194). Washington, DC: American Geophysical Union.

- Simon, A., & Collison, A. J. (2002). Quantifying the mechanical and hydrologic effects of riparian vegetation on streambank stability. *Earth Surface Processes and Landforms* 27(5), 527-546.
- Simon, A., Wolfe, W.J., & Molinas, A. (1991, March). Mass wasting algorithms in an alluvial channel model. In S. S. Fan & Y. H. Kuo (Eds.) *Proceedings of the 5th Federal Interagency Sedimentation Conference* (U. S. Subcommittee on Sedimentation, 2: 8-22 – 8-29), Las Vegas, NV. Retrieved online (on 03/18/2016) at HathiTrust Digital Library's website: <http://babel.hathitrust.org/cgi/pt?id=umn.31951d00521601d;view=1up;seq=1>
- Simon, A. (1989). A model of channel response in disturbed alluvial channels. *Earth Surface Processes and Landforms* 14(1), 11-26.
- Simon, A., & Hupp, C. R. (1986, March). Channel evolution in modified Tennessee channels. In *Proceedings of the Fourth Federal Interagency Sedimentation Conference* (Subcommittee on Sedimentation of the Interagency Advisory Committee on Water Data, 2) Las Vegas, NV.
- Sklar, L. S., & Dietrich, W. E. (2001). Sediment and rock strength controls on river incision into bedrock. *Geology* 29(12), 1087-1090.
- Smith, R. L. (1977). *Elements of Ecology and Field Biology*, New York, NY: Harper and Row Publishers.
- Snyder, N. P., Nesheim, A. O., Wilkins, B. C., & Edmonds, D. A. (2013). Predicting grain size in gravel-bedded rivers using digital elevation models: Application to three Maine watersheds. *Geological Society of America Bulletin* 125, 148–163.
- Soar, P. J., & Thorne, C. R. (2001). *Channel Restoration Design for Meandering Rivers* (ERDC/CHL CR-01-1). Vicksburg, MS: U.S. Army Engineer Research and Development Center, Flood Damage Reduction Research Program.
- Soar, P. J., & Thorne, C. R. (2011). Design Discharge for River Restoration. In A. Simon, S. J. Bennett, & J. M. Castro (Eds.). *Stream Restoration in Dynamic Fluvial Systems: Scientific Approaches, Analyses, and Tools*. Washington, DC: American Geophysical Union.
- Spurr, S. H. & Barnes, B. V. (1980). *Forest Ecology* (3rd ed.). New York, NY: John Wiley & Sons.
- Southern Rockies Seed Network (2015). *Guidelines for the Ethical Harvest of Plant Materials (2015)*, Fort Collins, CO: Synergy Ecological Restoration. [ed.: Available by request from john@synergy3.org]
- St. John, T. (2000). *The Instant Expert Guide to Mycorrhiza: The Connection for Functional Ecosystems*. Gilroy, CA: Green Diamond Biological. Retrieved online (on 03/18/2016) at

Green Diamond Biological's website: <http://green-diamond-biological.com/wp-content/uploads/2012/03/Mycorrhiza-Primer.pdf>

Strahler, A. N. (1957). Quantitative analysis of watershed geomorphology. *Transactions, American Geophysical Union* 38(6): 913-920.

Terzaghi, K. (1943). *Theoretical soil mechanics*. New York, NY: Wiley.

Texas Department of Transportation (1999). *Field Performance Testing of Selected Erosion Control Products*. Bryan, TX: TXDOT/TTI Hydraulics and Erosion Control Laboratory.

Thayer, G. W., McTigue, T. A., Bellmer, R. J., Burrows, F. M., Merkey, D. H., Nickens, A. D., . . . Pinit, P. T. (2003). *Science-Based Restoration Monitoring of Coastal Habitats, Volume One: A Framework for Monitoring Plans Under the Estuaries and Clean Waters Act of 2000 (Public Law 160-457)* (NOAA Coastal Ocean Program Decision Analysis Series No. 23(1)). Silver Spring, MD: NOAA National Centers for Coastal Ocean Science.

Thomsen, B. W., & Hjalmanson, H. W. (1991). *Estimated Manning's roughness coefficients for stream channels and flood plains in Maricopa County, Arizona*. Phoenix, AZ: Flood Control District of Maricopa County.

Thorne, C. R. (1999). Bank processes and channel evolution in the incised rivers of north-central Mississippi (pp. 97-122) In S. F. Darby and A. Simon (Eds.). *Incised river channels: processes, forms, engineering, and management*. Chichester, UK: Wiley.

Thorne, C. R. (1990). Effects of vegetation on riverbank erosion and stability. In: J. B. Thornes (Ed.) *Vegetation and Erosion*. Chichester, UK: Wiley.

Thorne, C. R. & Osman, A. M. (1988). Riverbank stability analysis. II: Applications, *Journal of Hydraulic Engineering* 114(2), 151-172.

U. S. Army Corps of Engineers (1987). *Corps of Engineers Wetlands Delineation Manual* (Technical Report Y-87-1). Vicksburg, MS: U. S. Army Corps of Engineers, Waterways Experiment Station, Environmental Laboratory.

U. S. Geological Survey (1963) *Summary of Floods in the United States During 1957*. (U.S. Geological Survey Water-Supply Paper 1652-C.) U. S. Department of Interior, Natural Resources Conservation Service, U. S. Geological Survey.

U. S. Geological Survey (2015) *StreamStats* [Web Application]. Retrieved online at <http://water.usgs.gov/osw/streamstats/>

- van Dyke, C. (2016). Nature's complex flume: Using a diagnostic state and transition framework to understand post-restoration channel adjustment of the Clark Fork River, Montana. *Geomorphology* 254, 1-15.
- Waldron, L. J. (1977). The shear resistance of root-permeated homogenous and stratified soil. *Journal of the Soil Science Society of America* 41(5), 843-849.
- Washington State Department of Fish and Wildlife, Inter-Fluve, Inc., Heiner, B., Buchanan, K., Powers, P., Birkeland, G., and White, D. (2003). *Integrated Streambank Protection Guidelines*. Olympia, WA: Washington State Aquatic Habitat Guidelines Program.
- Wayland, R. H., III (1997). Environmental Protection Agency, from Congressional Testimony on June 26, 1997.
- Wheaton, J.M., Darby, S.E. and Sear, D., 2008. The Scope of Uncertainties in River Restoration. In: S.E. Darby and D. Sear (Editors), *River Restoration: Managing the Uncertainty in Restoring Physical Habitat*. John Wiley and Sons, Chichester, U.K., pp. 21-39.
- Wilkerson, G. V., Kandel, D. R., Perg, L. A., Dietrich, W. E., Wilcock, P. R., & Whiles, M. R. (2014). Continental-Scale Relationship Between Bankfull Width and Drainage Area for Single-Thread Alluvial Channels. *Water Resources Research* 50(2), 919-936.
- Wohl, T. (2008) The Effect of Bedrock Jointing on the Formation of Straths in the Cache la Poudre River Drainage, Colorado Front Range, *Journal of Geophysical Research*, Vol. 113, No.1, January.
- Wohl, E. (2013). Floodplains and wood. *Earth-Science Reviews* 123, 194-212.
- Wohl, E., Bledsoe, B., Fausch, K., Kramer, N., Bestgen, K., and Gooseff, M. (2016). Management of large wood in streams: An overview and proposed framework for hazard evaluation. *Journal of the American Water Resources Association* 1-21. Retrieved online at JAWRA's website: <http://onlinelibrary.wiley.com/enhanced/doi/10.1111/1752-1688.12388>
- Wohl, E., Lane, S. N., & Wilcox, A. C. (2015). The Science and Practice of River Restoration. *Water Resources Research* 51(8), 5974-5997.
- Wolman, M. G., & Miller, J. P. (1960). Magnitude and Frequency of Forces in Geomorphic Processes. *The Journal of Geology* 68(1), 54-74.
- Wu, T. H., McKinnell, W. P., III, & Swanston, D.N. (1979). Strength of tree roots and landslides on Prince of Wales Island, Alaska. *Canadian Geotechnical Journal* 16(1), 19-33.
- Yochum, S. E. (2015). *Guidance for Stream Restoration and Rehabilitation*. (Technical Note TN-102.1). Fort Collins, CO: U.S. Department of Agriculture, Forest Service, National Stream & Aquatic Ecology Center.

Yochum, S. E., Comiti, F., Wohl, E., David, G. C., & Mao, L. (2014). *Photographic Guidance for Selecting Flow Resistance Coefficients in High-Gradient Channels*. (General Technical Report, RMRS-GTR-323). Fort Collins, CO: U.S. Department of Agriculture, Forest Service, Rocky Mountain Research Station.

Yochum, S. E., Bledsoe, B. P., David, G. C., & Wohl, E. (2012). Velocity Prediction in High-Gradient Channels. *Journal of Hydrology* 424-425, 84-98.

APPENDICES

A. FIELD GUIDE FOR HARVESTING AND INSTALLING WILLOW AND COTTONWOOD CUTTINGS

FIELD GUIDE FOR HARVESTING AND INSTALLING WILLOW AND COTTONWOOD CUTTINGS

John Giordanengo
Synergy Ecological Restoration
www.synergy3.org

Randy Mandel
Golder Associates
www.golderassociates.com



COLORADO
Colorado Water
Conservation Board
Department of Natural Resources



Support for this field guide and training was provided by the Colorado Water Conservation Board and Synergy Ecological Restoration, and is conducted in partnership with Rocky Mountain Flycasters.

June 06, 2015

INTRODUCTION AND PURPOSE

This field guide covers basic techniques for selecting, harvesting, and installing willow and cottonwood cuttings for restoration projects. It also provides a basic understanding of the biology of Salicaceae, the family that includes all willow and cottonwood species. Knowledge of Salicaceae biology can inform plant selection, harvest, and storage methods, and proper techniques can play a key role the success of a diversity of restoration projects, from live staking to advanced bioengineering structures.

IMPORTANCE OF WILLOWS AND COTTONWOODS IN RESTORATION

In arid regions of the Rocky Mountains, willows and cottonwoods provide important wildlife cover for nesting birds and small mammals, and forage for elk, moose, and other herbivores. Willows and other riparian vegetation provide effective soil stabilization through the large web of underground roots that bind soil particles together. The above-ground biomass of riparian vegetation slows water velocities and therefore aids in reducing shear stress along stream banks, road embankments, and other erosion-prone areas. Willows have a number of characteristics that make them resilient to high-velocity flood waters, burial by sediments, long periods of inundation, high winds, and heavy browsing by wildlife. Cottonwoods provide similar benefits, as well as providing structural diversity (i.e., variety of canopy heights) in a riparian habitat. Furthermore, willows and cottonwoods provide essential shade and organic matter inputs to rivers, both of which are critical to the quality of aquatic habitats. Such riparian vegetation also facilitates nutrient uptake of effluents such as nitrates and phosphates.

BIOLOGY, BEAVERS, AND BENEFITS

Willows and cottonwoods are deciduous woody plants in the Willow Family (Salicaceae) that typically occur in mesic sites such as riparian areas (i.e., riverside habitats) and other wetland habitats. Willows are classified in the genus *Salix*, and cottonwoods are in the genus *Populus*. Both willows and cottonwoods have an important feature in their biology that make them excellent candidates for use in ecological restoration.

Willow and cottonwood stems can develop new roots readily from dormant buds and adventitious buds (i.e., buds that develop in an “atypical” place rather than at the branch tip or in leaf axils) when in contact with water or moist soil. This strategy is helpful in habitats where beaver routinely cut and haul willows to construct dams and lodges. Should a stem break loose and flow down river, or become dislodged by a flood, the stems root readily in the muddy riverbanks. And so in the course of riparian restoration we find ourselves following in the footsteps of the beaver. However, incorrect selection of species, as well as improper storage, handling, timing, and installation techniques, can produce widely varying results. This guide provides tips and information to help you improve your chances of success in a riparian restoration project.

APICAL CONTROL IN SHRUBS

All woody plants, including willows and cottonwoods, produce a mix of hormones including auxins, cytokinins, ethylene, and gibberellins. Hormones are substances that are produced in small amounts and influence the growth, development, and differentiation of cells and tissues. The specific ratio and timing of hormone release has strong control over plant growth. One example of this is known as *apical control*, where the top branches of a plant (i.e., apical or terminal buds) have an influence over the lower branches. Apical control occurs widely among willows and cottonwoods, where auxins produced by terminal buds are transported to lateral buds (i.e., buds along the stem below the terminal bud) and adventitious buds to convey a signal to “stay dormant.” When the apical bud is removed by a browsing animal or severed by a willow harvester, the hormonal signal from auxin is interrupted, which stimulates the growth of lateral and adventitious buds. In heavily browsed areas, it is the removal of the terminal buds that causes a bushy appearance in both willow and cottonwood stands. Under some conditions, however, and for certain species (e.g., sandbar willow, *Salix exigua*), removal of the terminal bud may not be necessary or desirable to achieve project goals. If a tree-like willow is desired, removing the terminal bud(s) is not recommended.

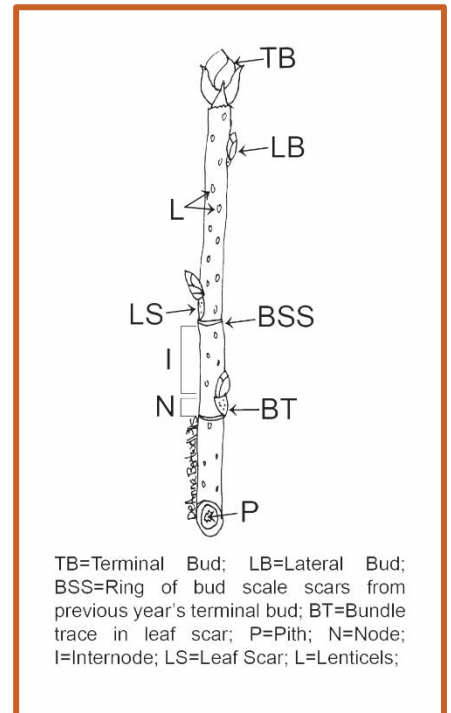

USING LIVE CUTTINGS FOR RESTORATION

Thanks to the nature of willow biology, and especially to the presence of adventitious and dormant buds that form roots when wet, live cuttings (poles, stakes, or whips) can be used in a variety of restoration practices. When installed properly and under the right environmental and moisture conditions, live cuttings can develop roots and above-ground shoots rapidly. Survival of these cuttings through the first growing season can range between 45% and 90% of installed cuttings. However, subsequent survival can be highly variable, and three seasons of monitoring is recommended before claiming success or admitting defeat for any willow restoration project. Lack of adequate soil moisture, poor timing, incorrect species choice, and improper selection of willow stems are important factors associated with poor survivorship of cuttings.

Careful attention to harvesting healthy stems, proper stem diameter and age, groundwater hydrology and hydroperiod, depth of installation, and good soil-to-stem contact all contribute to successful restoration projects.



Roots sprouting from adventitious buds after 13 days of soaking. USDA-NRCS, Aberdeen Plant Materials Center

SELECTING THE RIGHT MATERIALS: GARBAGE IN = GARBAGE OUT

The best willow installation job often fails when the cuttings are not properly selected and stored ahead of time. These simple rules will improve the success of every willow and cottonwood project and help to protect the resource.

Harvest Location: Select a source population as close to your project site as feasible, preferably within the same drainage. Harvest species that occur in the same site conditions (e.g., hydrology, landscape position, elevation) as the conditions of your restoration site. Avoid sourcing plant materials more than 1,000 feet in elevation above or below your restoration site.



Healthy Stems: Always select healthy stems (i.e., “green” wood in cross-section) that are: relatively straight, covered in smooth bark (i.e., not furrowed or damaged), and free of insects, disease, or fungal damage. For most willow and cottonwood species, stems older than 4 years of age produce fewer adventitious buds and are lower in vigor than younger stems. This is especially true for species such as peachleaf willow (*Salix amygdaloides*), Bebb’s willow (*S. Bebbiana*), and many alpine and subalpine species.

HARVEST ETHICALLY -- LEAVE MORE THAN YOU TAKE!

Follow ethical harvest guidelines to conserve health of the donor stand:

- **Know before you go! Obtain approval from land owner (public or private) before harvesting. In some cases a permit may be required.**
- **Remove no more than 20% of the branches from any single willow.**
- **Never remove more than 30% of the overall canopy cover from any willow stand.**
- **Harvest stems evenly through the stand (e.g., not from one side of the plant only).**
- **In Preble’s Meadow Jumping Mouse Habitat (<7,400’ elevation on the Colorado Front Range), and in other sensitive wildlife habitats, more stringent harvest guidelines should be followed.**

HARVESTING AND PREPARATION

Tools: Lopping shears, hand by-pass pruners, small wood saws or brush cutters, twine, labels, buckets, trash cans.

HARVESTING & STORING

Harvest cuttings during the dormant season (i.e., between fall dormancy/leaf abscission and spring bud break):

Select stems ½ to 1¼ inches (between pinky and thumb width) in diameter for most projects. Some projects may require willow stems up to 3 inches in diameter or cottonwoods up to 6 inches in diameter (e.g., posts) where longer or stronger cuttings are required to reach deep groundwater. In this case, cuttings may need to be installed into the soil via pounding, hammer drills, water stingers, augers, or other means.

Cut stems to length, as determined by specific project needs (e.g., depth to late-summer water table, severity of erosion and flood damage). Cuttings can range from 18 inches to 12 feet long depending on depth to groundwater and height of competing vegetation. Remove the cutting with a clean diagonal cut at the base of the stem. The diagonal surface differentiates the rooting end from the above ground portion, and facilitates installation.

Leave the terminal buds and a few upper branches intact until installation. Remove all but the top few lateral (i.e., side) branches by clipping them as close to the stem as possible. Use caution to avoid damaging the stem while trimming the lateral branches. Removing lateral branches assists in transport and storage, helps maintain an appropriate root-to-shoot ratio, and reduces transpiration losses prior to root establishment. Logistically, a trimmed willow cutting is easier to install down a narrow pilot hole.

Bundle cuttings in groups of 50 or 100 by species. Keep bundles cool, moist, and shaded during transportation and on-site storage.

Prior to planting, **soak cuttings** in water for 7-14 days to increase the rate and degree of adventitious root formation. Cuttings can be soaked in buckets, streams, or ponds with well-oxygenated water. Roughly 50 to 80% of the length of the cutting should be in contact with water while soaking. Plants should be weighted down when soaked in a horizontal position. Research shows significant increase in survival for willows that are pre-soaked prior to planting (Tilley and Hoag 2008).

CAUTION – Dangerous Stowaways!

Avoid soaking cuttings in water bodies that may harbor aquatic nuisance species such as New Zealand mudsnail, Eurasian milfoil, chytrid fungus, and other pests that are exotic and known to negatively impact native species. To be safe, soak your cuttings in buckets of tap water or in water from your restoration site.

Pre-soaking willow cuttings.
(USDA-NRCS, Aberdeen Plant Materials Center)



Tools: planting bars (dibbles), rebar, rubber mallet/mini sledge, post-hole diggers, electric hammer-drills, soil augers, power stingers, shovels, buckets, lopping shears.

INSTALLING LIVE CUTTINGS

Location location location. It's as true with willow and cottonwood plantings as it is in real estate: location matters! While a full site analysis and planting location plan is beyond the scope of this field guide, some tips include: (1) previous knowledge of soil moisture, hydrographs, and/or groundwater monitoring well data is extremely helpful; (2) avoid installing cuttings in dense herbaceous wetland communities, as such soils can be anaerobic and difficult for survivorship of fresh adventitious roots; (3) avoid installing cuttings too close to the stream edge, especially in unconsolidated soils, as it is likely the eroding streambank will result in the loss of your planted materials prior to establishment; (4) avoid installing willows too far away from the water, such that the bottom of the cutting and the adjacent buds are not in contact with the low/dry-season groundwater – unless utilizing artificial irrigation.

Optimal time for willow and cottonwood planting varies by region, plant community, and local hydrologic (i.e., stream and groundwater hydrology) regime. Typically, cuttings are installed after spring thaw but before bud break, or in fall after leaves change color and/or drop. If planting in fall, be sure to install cuttings deep enough (i.e., at least 2 feet) to avoid being dislodged from the ground by winter freeze-thaw cycles. In river systems with fairly unaltered flow regimes, planting willows and cottonwoods after peak discharge (i.e., during the receding limb of the hydrograph) is recommended, as long as the timing in that location is prior to bud break. In altered systems, where surface and groundwater elevations are known to drop quickly, early season (i.e., very early spring) planting is recommended.

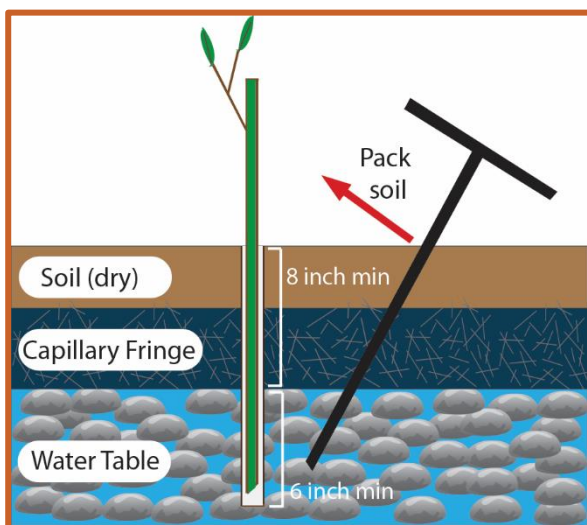

Pilot holes allow for easier installation without damaging the cuttings. In soft soils, pilot holes may not be necessary. Prepare pilot holes by pounding in rebar or other appropriate tools. Mechanical devices (e.g., stingers or augers) can also be used to prepare deeper holes in difficult soils.

The bottom is of top importance. The bottom 6-8 inches of the cutting should be installed below the expected dry-season water table. **NOTE: Sufficient depth of installation is the most difficult task for any laborer.** Generally, 50-80% of the cutting should be installed below ground.

TIP: many cuttings are not installed deep enough to reach the low-season groundwater. To adequately address this, ensure that the pilot hole reaches a depth of at least 6 inches into the estimated low-season groundwater.

INSTALLING LIVE CUTTINGS (CONTINUED)

Backfill around cuttings to ensure good soil-to-stem contact (i.e., without air pockets). When installing cottonwood posts or cuttings into pre-augered holes, add a pancake batter-like slurry of soil and water into the hole, allowing sediment to displace any air pockets as water leaches into underlying soil.

NOTE: Willow and cottonwood roots cannot survive in dry air! Tamp your soil around the cuttings to eliminate air pockets.



IMPORTANT INSTALLATION TIPS

- Remove the bottom 1 to 2 inches of the cutting with a clean diagonal cut to “freshen up” the conductive xylem cells prior to installation.
- Be sure upward-facing tips of lateral buds point sky-ward and the diagonally cut end, usually the thicker end of the cutting, is inserted into the ground.
- Under normal conditions, the above ground portion should be trimmed to maintain from 2 to three lateral buds. Trimmed top growth is less likely to snag on water-borne debris and maintains more favorable internal water relations. Longer top growth can be beneficial under highly competitive conditions so that competing plants do not overshadow the cutting during the active growing season.
- To help address the challenges of possible debris flows, the average finished height for the placed cuttings should be from 8 to 12 inches above the ground surface. It should be understood that each site will require slight adjustments in placement methodology to account for local conditions.
- Cracked, diseased, or mangled cut ends will increase susceptibility to pest damage, decreasing survival rates. If cuttings are damaged from installation, provide a clean diagonal cut just below the damaged surface.

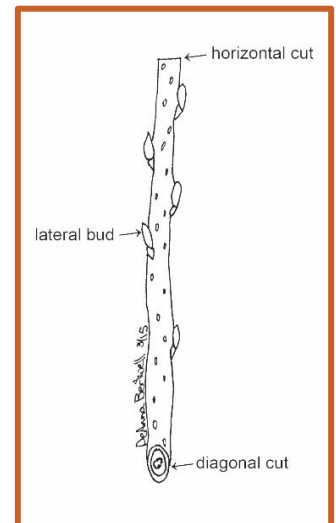

SOFTWOOD CUTTINGS

Softwood cuttings are comprised of the current year's growth. For many non-salicaceae species, softwood cuttings can be used in a nursery setting to propagate container stock. To improve success, follow these tips:

- Perform the snap test to determine if softwood is in an appropriate stage for harvesting.
- Include 6-8 inches of softwood and 6 inches of hardwood with your cutting.
- Place entire cutting in water immediately.
- Remove all but top 3-6 leaves (before harvesting).
- Transport cuttings safely to propagation facility within four hours of harvesting (sooner the better).

CLUSTER PLANTING

To improve chance of establishment per planting site, install multiple cuttings in a single larger hole (cluster planting, Hoag 2009). Typically, 3 cuttings per hole is sufficient. This is a useful technique in cobble-dominated substrate such as along river banks.

GLOSSARY

Adventitious Buds/Roots: buds or roots that develop in an “atypical” place rather than at the branch tip or in leaf axils.

Apical Dominance: The phenomenon whereby the main central stem of a plant grows more strongly and readily than the lateral or side stems.

Bioengineering: Also referred to as “biotechnical slope protection,” this is the integration of living woody and herbaceous materials along with organic and inorganic materials to increase the strength and structure of soil.

Buffer: A vegetated area of grass, shrubs, or trees designed to capture and filter runoff from surrounding land uses.

Canopy: The overhead branches and leaves of vegetation.

Capillary Fringe: The distance water is wicked upwards above the water table by capillary action in the soil.

Coir: A woven mat of coconut fibers used for various soil erosion control applications; Biodegrades after a period of a few years.

Fascine: A long bundle of brushwood or cuttings that is typically installed near the toe of the slope, and is used to stabilize stream banks and other slopes.

Leaf Abscission: The process by which a plant sheds some of its parts, such as leaves, spent flowers, secondary twigs, seeds, and ripe fruits.

Live Cuttings: Leafless stem cuttings of woody plant species.

Pilot Hole: A pre-drilled or augered hole in the soil substrate created in advance before installing a live cutting.

Riparian Area: An ecosystem situated between aquatic and upland environments and is characterized by greater soil moisture than adjacent upland areas. Riparian areas are periodically influenced by flooding.

Root-to-Shoot Ratio: The dry weight of root biomass divided by the dry weight of shoot biomass. A plant that has a greater biomass of leaves and stems, compared to the biomass of its roots, would have a low root-to-shoot ratio. A low root-to-shoot ratio is considered an unhealthy condition for many plants.

Stinger: A tool used to create holes to use for planting cuttings from woody species.

Wattle: A sausage-like bundle of plant cuttings used to stabilize stream banks and other slopes.

Xylem: A compound tissue found in vascular plants used to transport water and some nutrients up from its roots to its stem, leaves, and buds.

RECOMMENDED READING AND LITERATURE CITED

For advanced techniques and additional detail, refer to the following recommended reading and literature cited.

Auble, G.T., Roelle, J.E., and A. Timberman. 2006. Riparian willow restoration at Arapaho National Wildlife Refuge. The green line online 17:4.
<http://coloradoriparian.org/GreenLine/V17-4/WillowRest.php>.

Bentrup, G. and Hoag, J.C. 1998. The Practical Streambank Bioengineering Guide. USDA-Natural Resources Conservation Service Plant Materials Center. P.O. Box 296. Aberdeen, ID 83210. (208) 397-4133.

Gage, E.A., and D. J. Cooper. 2004. Controls on willow cutting survival in a montane riparian area. *Journal of Range Management* 57:597-600.

Hoag, J.C. 2007. How to plant willows and cottonwoods for riparian restoration. TN (Technical Note) Plant Materials No. 23. USDA Conservation Services, Boise, Idaho. 22 pp.

Hoag, J.C. 2009. Cluster Plantings: a way to plant live unrooted cuttings in coarse soils, including sands, gravels, and cobbles. Hoag Riparian & Wetland Restoration Guides. No. 27, December, 2009.

Native Plant Revegetation Guide for Colorado: Caring for the Land Series, V. III. 1998. Edited by Jim von Loh, Colorado State Parks, Colorado Natural Areas Program. October 1998.

Natural Resources and Parks, Water and Land Resources Division, King County, WA. 2004. Live stake cutting and planting tips. <http://dnr.metrokc.gov/wlr/pi/Cutting.htm>.

Schaff, S.D., Pezeshki, S.R., Shields, F.D., Jr. 2002. Effects of pre-planting soaking on growth and survival of black willow cuttings. *Restoration Ecology* 10:267–274.

Tilley, D., and J.C. Hoag. 2008. Evaluation of fall versus spring planting of dormant hardwood willow cuttings with and without soaking treatment. NRCS Riparian/Wetland Project Information Series No. 25, Fall 2008.

Walter, J., Hughs, D., and D. Moore. 2005. Streambank revegetation and protection: a guide for Alaska (step-by-step fliers).
<http://www.sf.adfg.state.ak.us/sarr/restoration/techniques/download.cfm>.

Zierke, M. 1994. Riparian/ Wetland Project Information Series No. 5: Collection, establishment and evaluation of unrooted woody cuttings to obtain performance tested ecotypes of native willows and cottonwoods. United States Department of Agriculture – Natural Resources Conservation Service, Plant Materials Center, Aberdeen, ID.